

8.1 T SERIES

SUITE OVERVIEW

The T Series is a collection of aluminium profiles designed to allow a designer to integrate cable trunking into internal partition walls. Potters aluminium cable trunking has been specifically designed for the installation and use of CAT6 cabling. When installed back-to-back, it can be used to form the base of a 92mm wall – a width that integrates perfectly with other Potter aluminium systems.

TECHNICAL SERVICES + SPECIFICATION

Technical advice is available from our experienced team. Please see our company information page for your closest team, or email specsupport@potters.co.nz

The Potter Interior Systems product catalogue is hosted on www.potters.co.nz, EBOSS website www.eboss.co.nz and Productspec website www.productspec.co.nz

CAD details are either individual components or fully assembled details for convenient transfer to specifiers drawings. The file formats available for download are .DWG, .DXF, .DWF, .PDF and Autodesk Revit .RVT

Specifications are also available online with Masterspec branded section 5211PP POTTER ALUMINIUM INTERNAL PARTITIONS from the following resources.

www.potters.co.nz

www.eboss.co.nz

www.masterspec.co.nz

www.productspec.co.nz

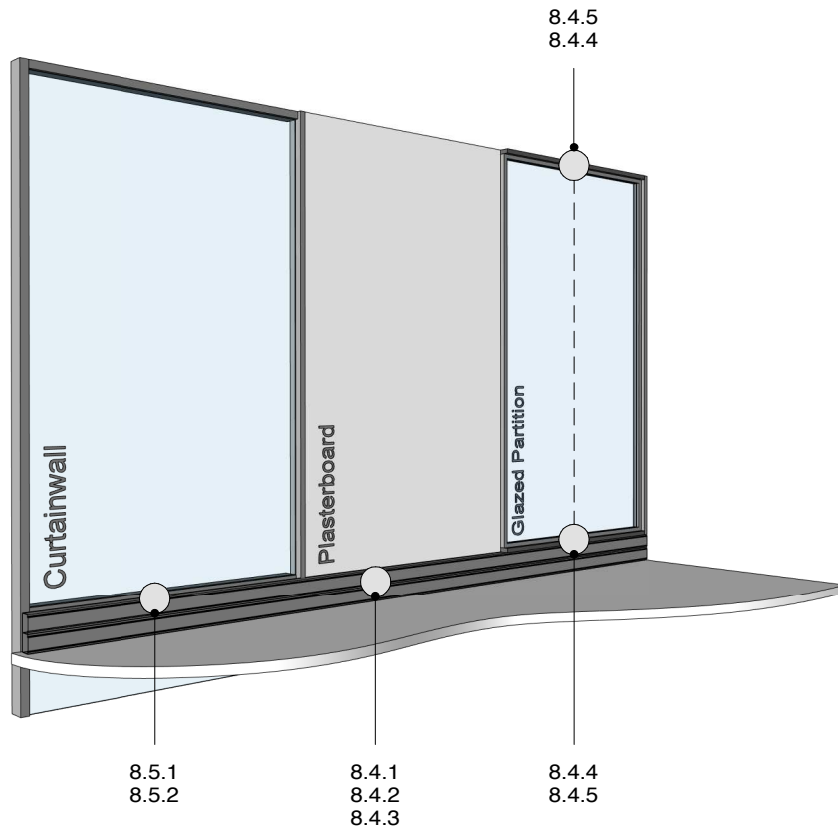

**POTTER ALUMINIUM SYSTEMS
T SERIES DETAIL REFERENCES**

8.3.1
SHEET

1:0, 1:25@A4
SCALE

A 23/05/16
ISSUED DATE

0800 POTTER (0800 768 837) WWW.POTTERS.CO.NZ
SUBJECT TO CHANGE WITHOUT NOTICE



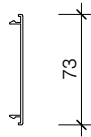

PAS 800
CAT6 TRUNKING
COVER PLATE

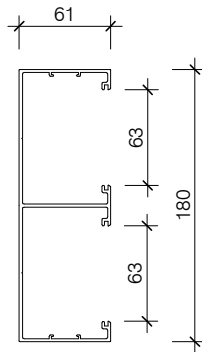

PAS 802
CAT6 180 TRUNKING

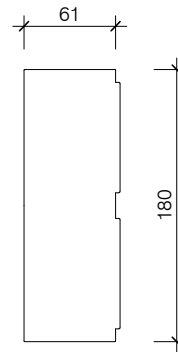

PASACC_ENDCAP802
CAT6 180 TRUNKING
END CAP

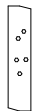

PASACC_CONNECTOR
TRUNKING
CONNECTOR

**POTTER ALUMINIUM SYSTEMS
T SERIES SUITE PROFILES**

8.3.2
SHEET

1:5@A4
SCALE

A 23/05/16
ISSUED DATE

0800 POTTER (0800 768 837) WWW.POTTERS.CO.NZ
SUBJECT TO CHANGE WITHOUT NOTICE



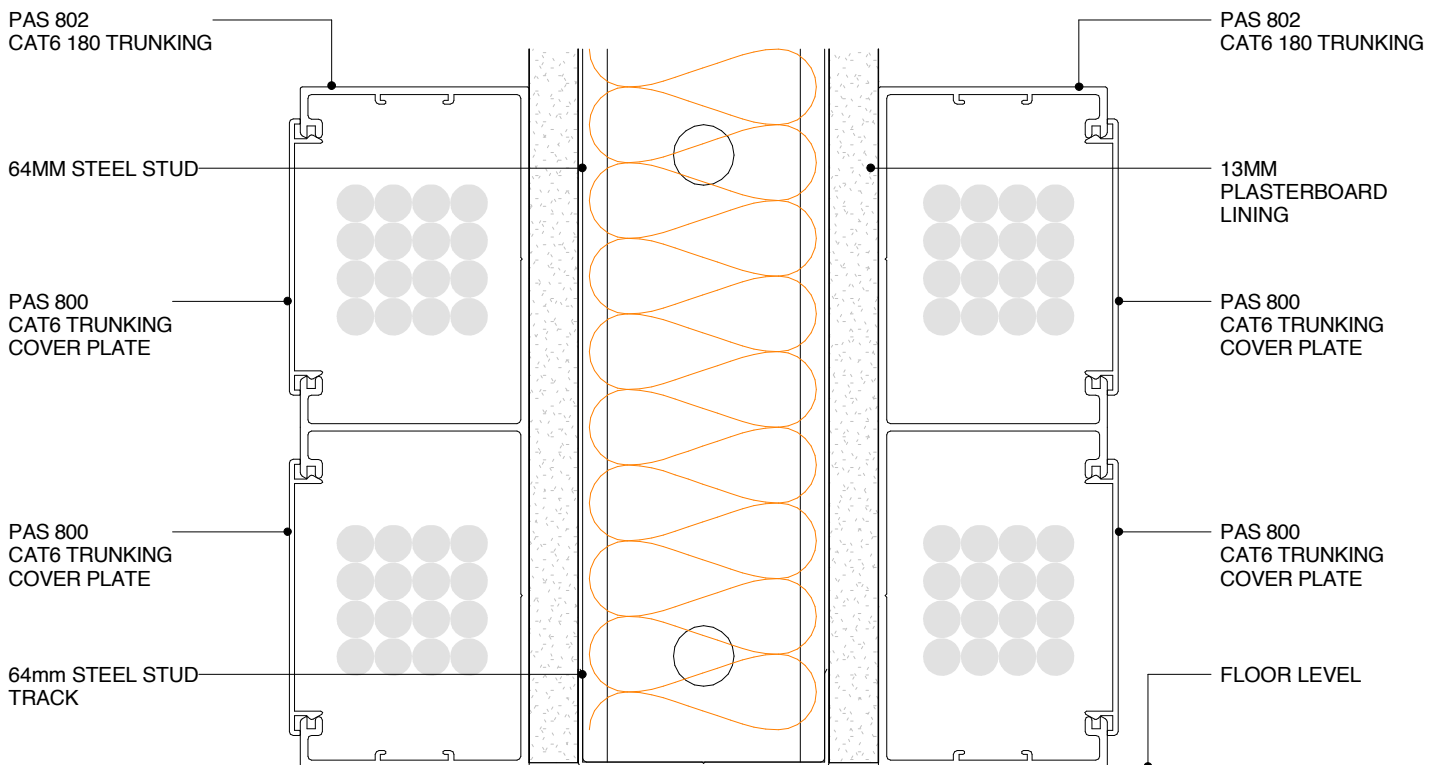
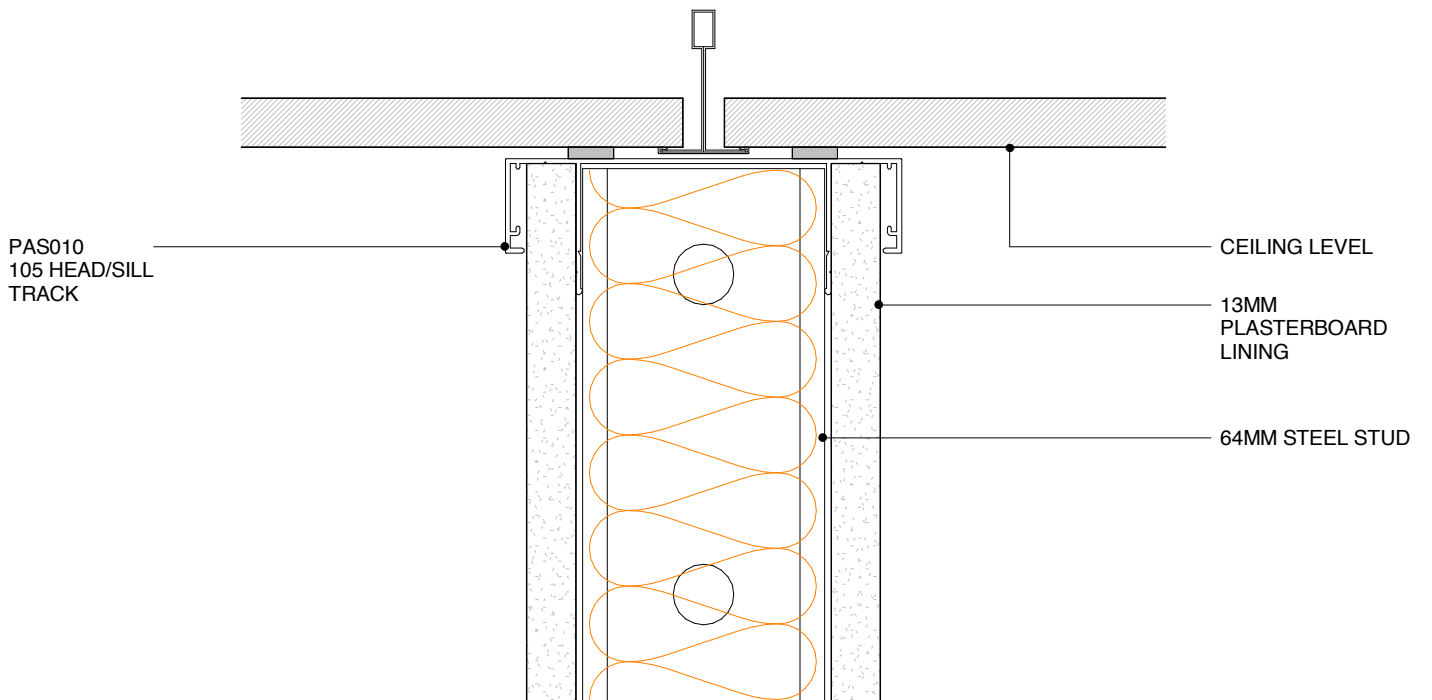

T SERIES

POTTER ALUMINIUM SYSTEMS
T SERIES CAT 6 TWO SIDED SYSTEM ON PLASTERBOARD
CROSS SECTION

8.4.1
SHEET

1:2@A4
SCALE

A 23/05/16
ISSUED DATE

0800 POTTER (0800 768 837) WWW.POTTERS.CO.NZ
 SUBJECT TO CHANGE WITHOUT NOTICE



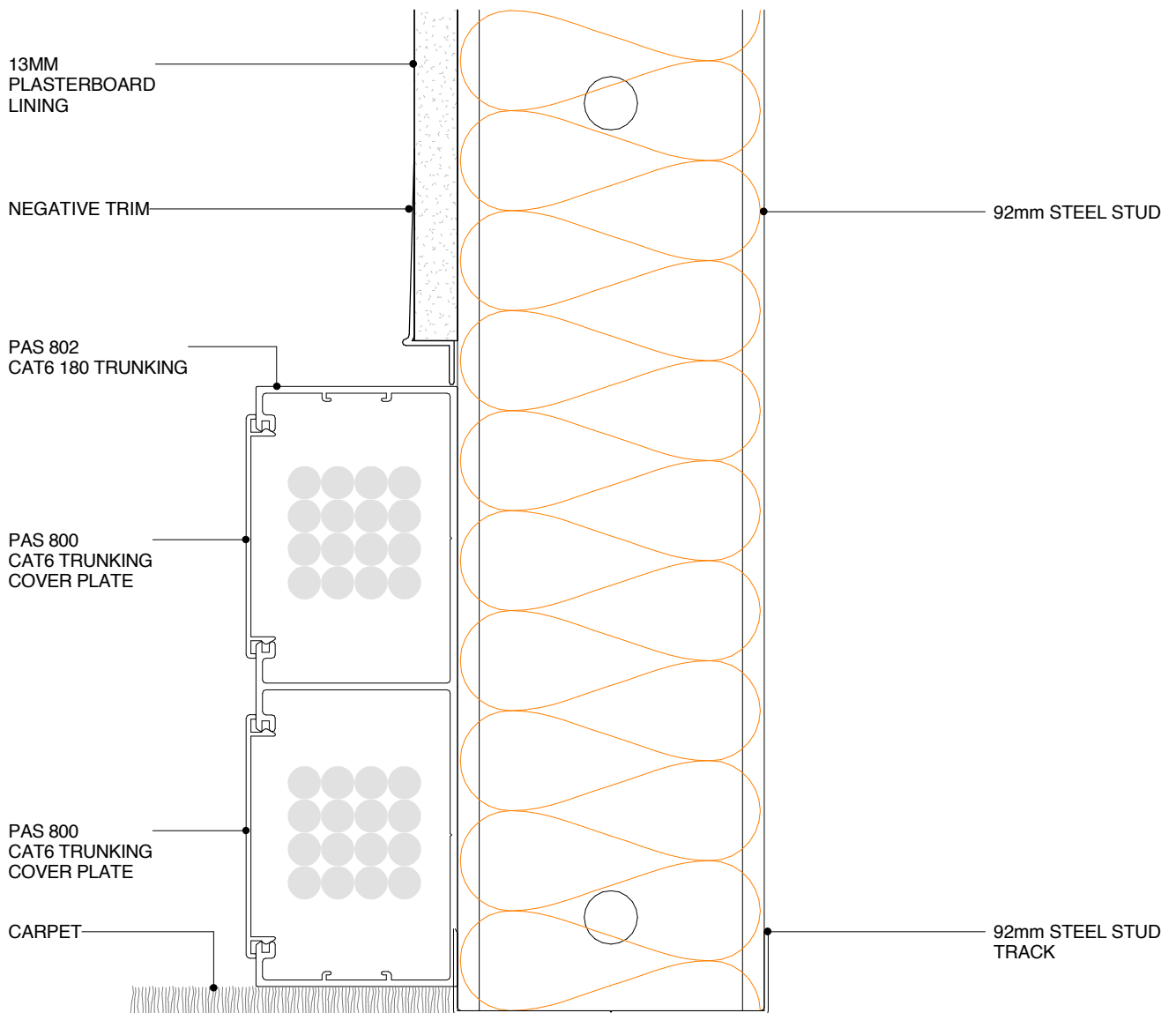

POTTER ALUMINIUM SYSTEMS
T SERIES CAT 6 ONE SIDED SYSTEM ON 92MM STEEL STUD
CROSS SECTION

8.4.2
SHEET

1:2@A4
SCALE

A 23/05/16
ISSUED DATE

0800 POTTER (0800 768 837) WWW.POTTERS.CO.NZ
SUBJECT TO CHANGE WITHOUT NOTICE



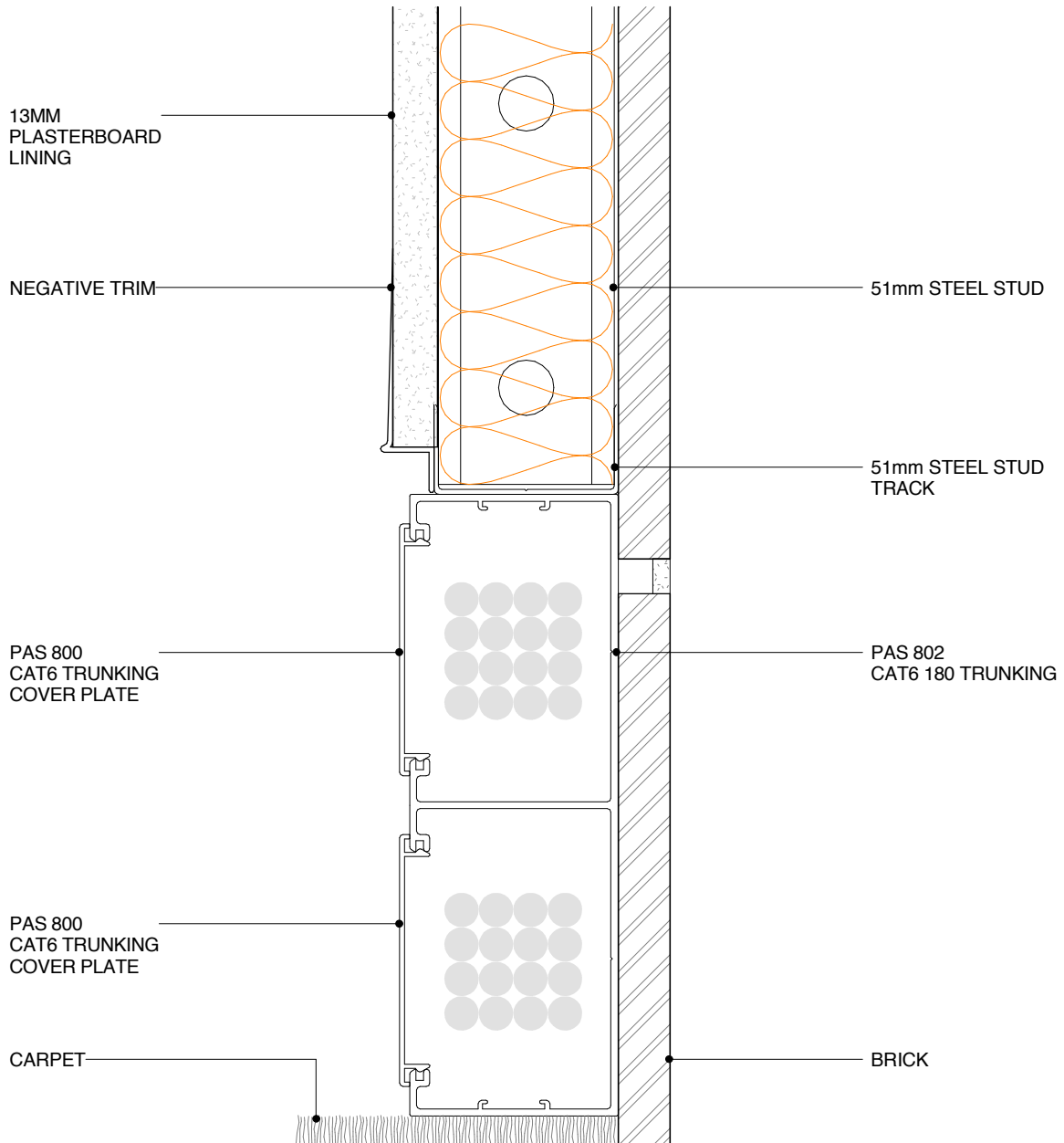

POTTER ALUMINIUM SYSTEMS
T SERIES CAT6 ONE SIDE TRUNKING ON BRICK WALL
CROSS SECTION

8.4.3
 SHEET

1:2@A4
 SCALE

A 23/05/16
 ISSUED DATE

0800 POTTER (0800 768 837) WWW.POTTERS.CO.NZ
 SUBJECT TO CHANGE WITHOUT NOTICE



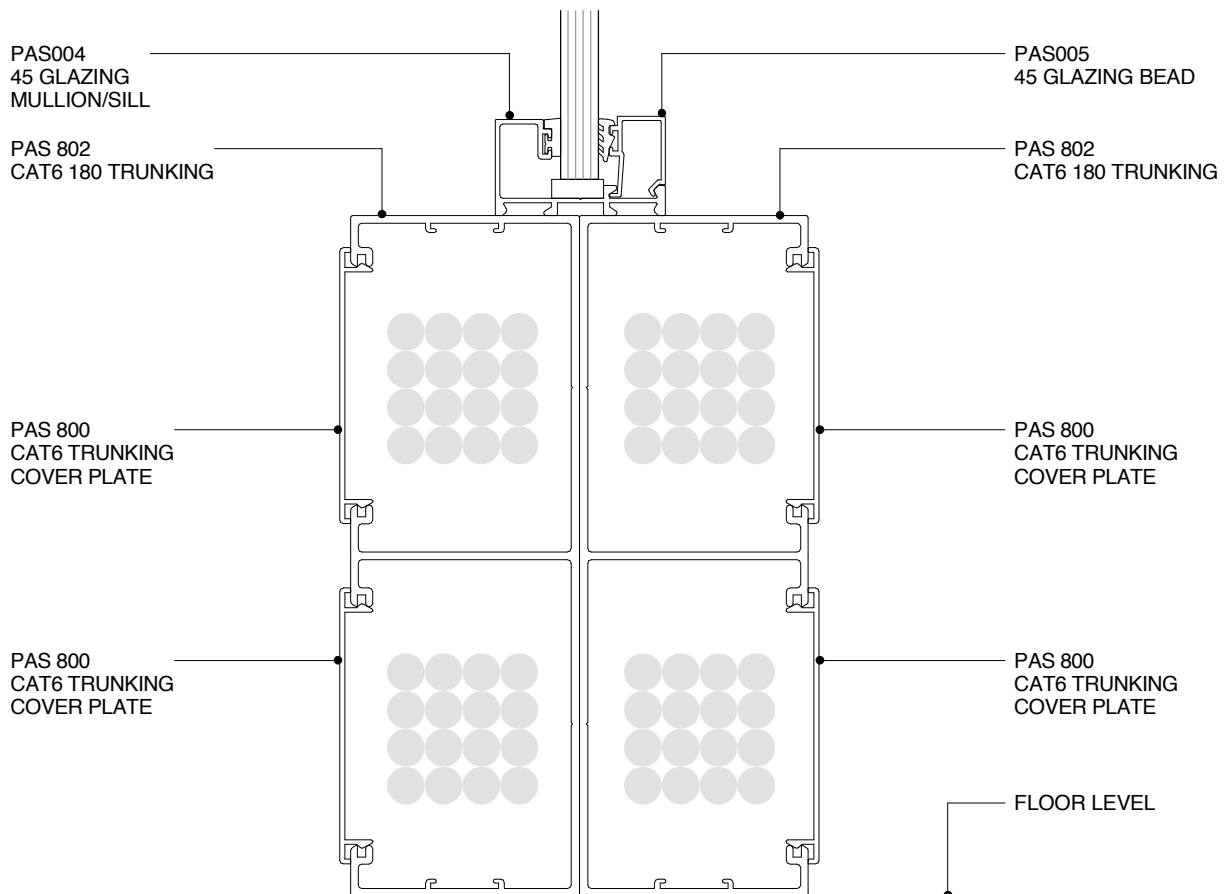
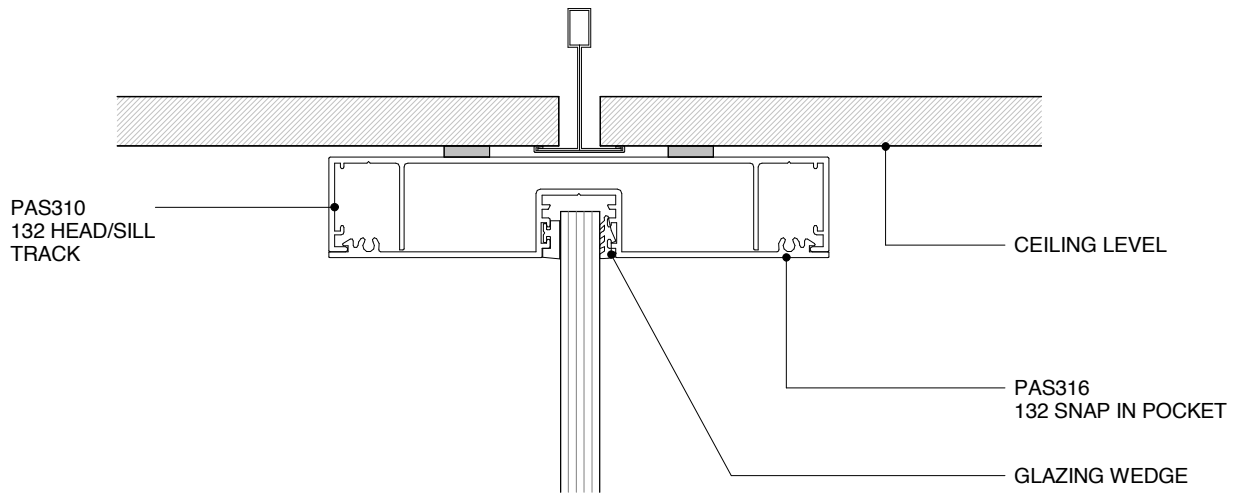

POTTER ALUMINIUM SYSTEMS
T SERIES CAT 6 TWO-SIDED SYSTEM GLAZING 45MM
CROSS SECTION

8.4.4
 SHEET (OLD REF X1.47)

1:2@A4
 SCALE

A 23/05/16
 ISSUED DATE

0800 POTTER (0800 768 837) WWW.POTTERS.CO.NZ
 SUBJECT TO CHANGE WITHOUT NOTICE



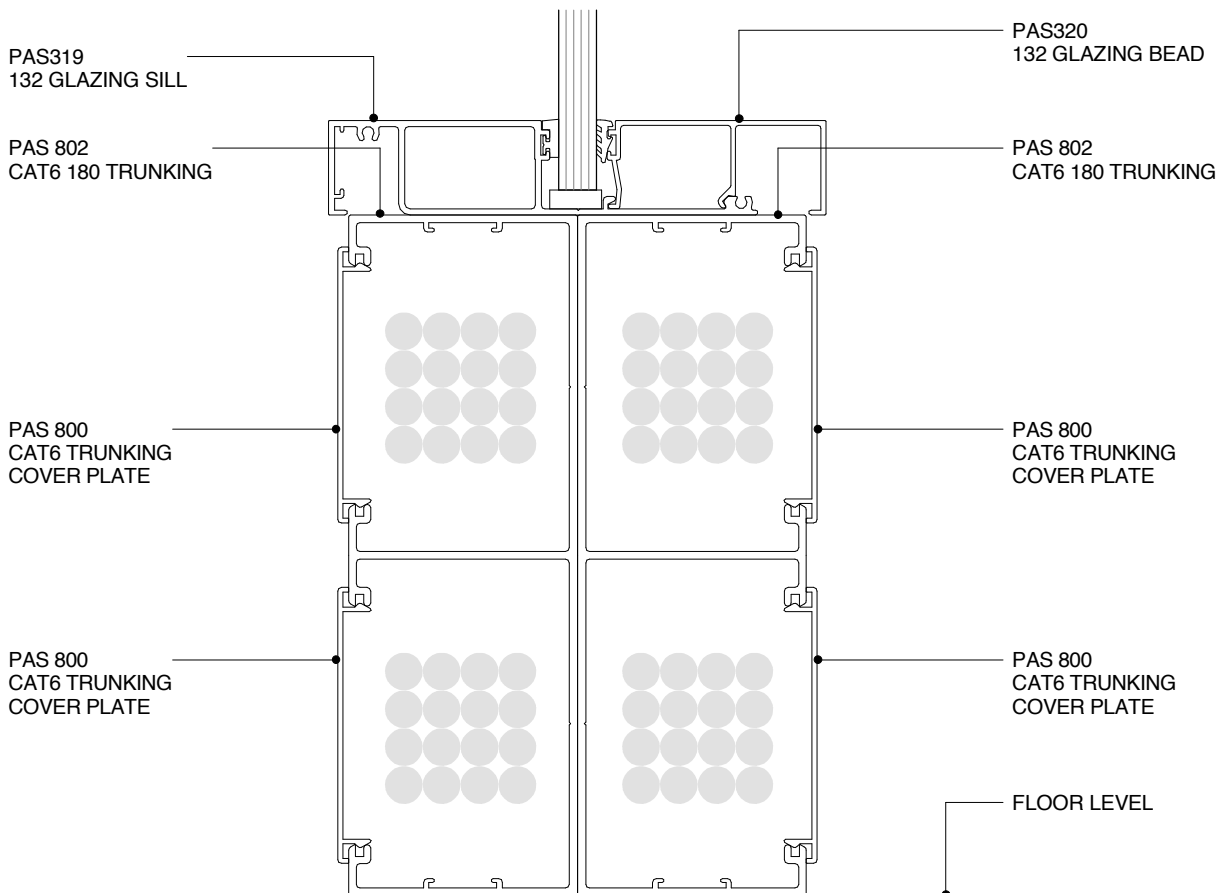
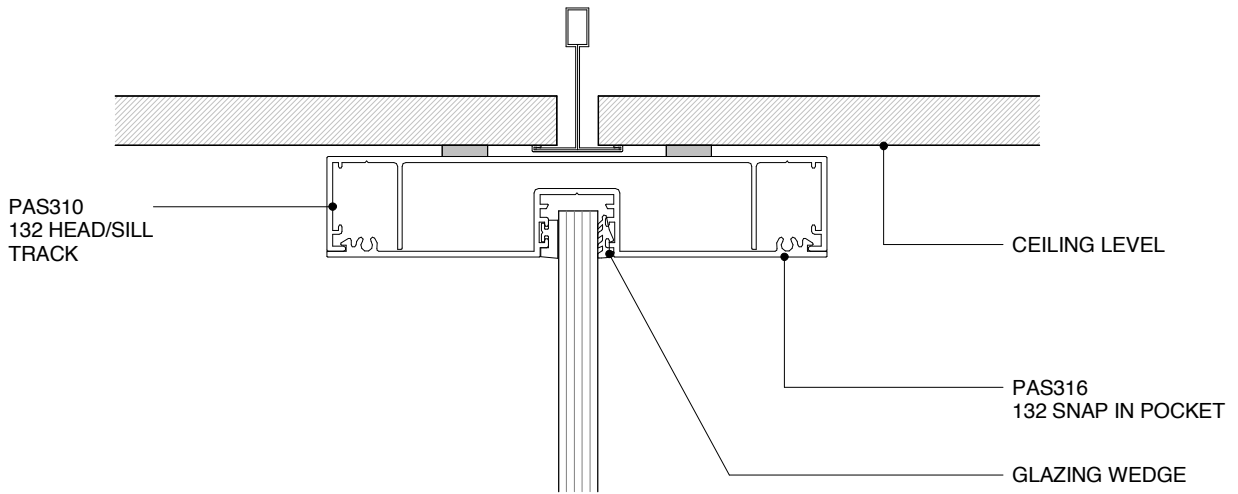

POTTER ALUMINIUM SYSTEMS
T SERIES CAT 6 TWO-SIDED SYSTEM GLAZING 132
CROSS SECTION

8.4.5

SHEET (OLD REF X1.48)

1:2@A4
SCALE

A 23/05/16
ISSUED DATE

0800 POTTER (0800 768 837) WWW.POTTERS.CO.NZ
SUBJECT TO CHANGE WITHOUT NOTICE



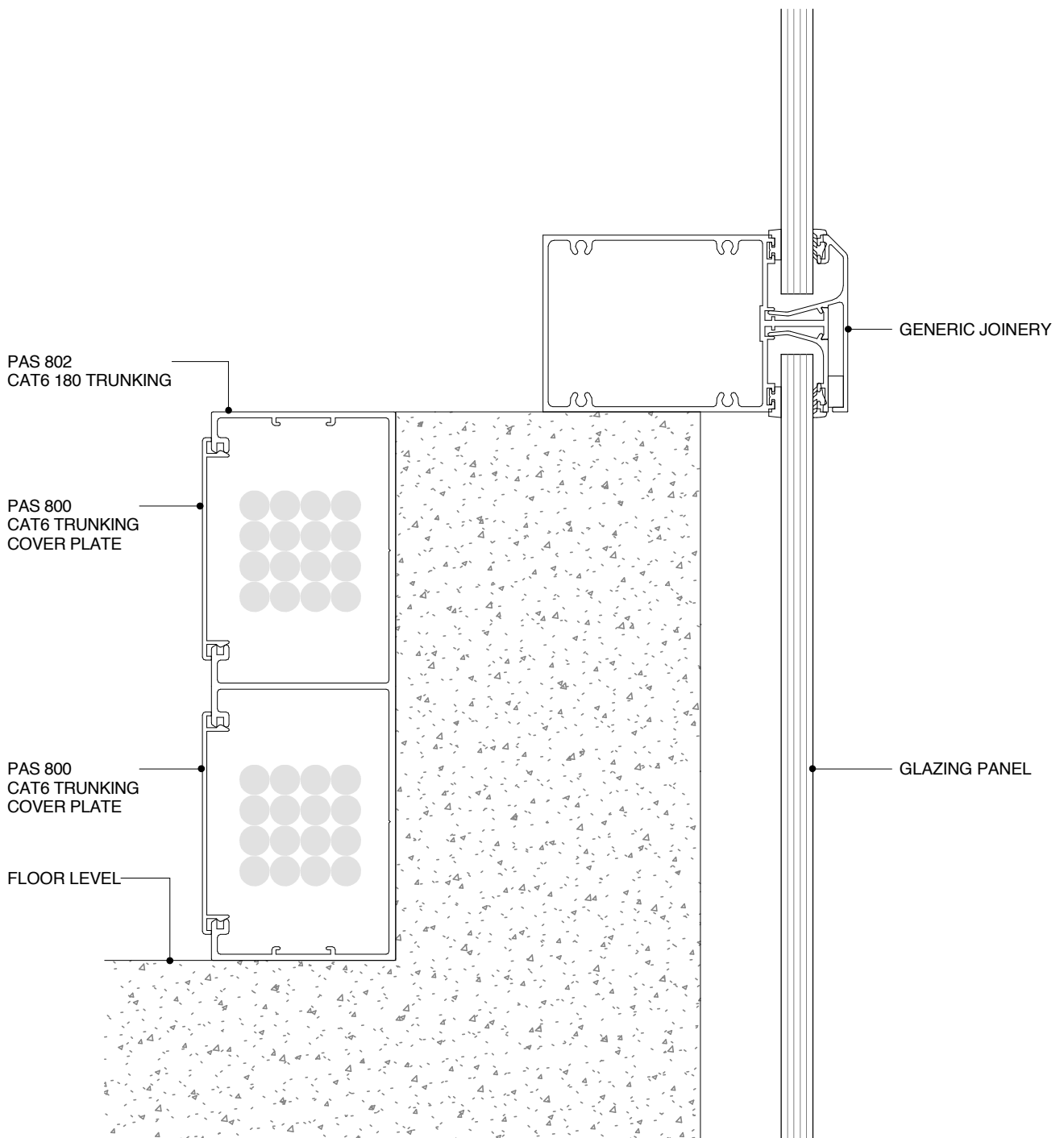

POTTER ALUMINIUM SYSTEMS
T SERIES CAT 6 AT CURTAIN WALL TO PRECAST FLOOR FIXING
CROSS SECTION

8.5.1
SHEET

1:2@A4
SCALE

A 23/05/16
ISSUED DATE

0800 POTTER (0800 768 837) WWW.POTTERS.CO.NZ
SUBJECT TO CHANGE WITHOUT NOTICE



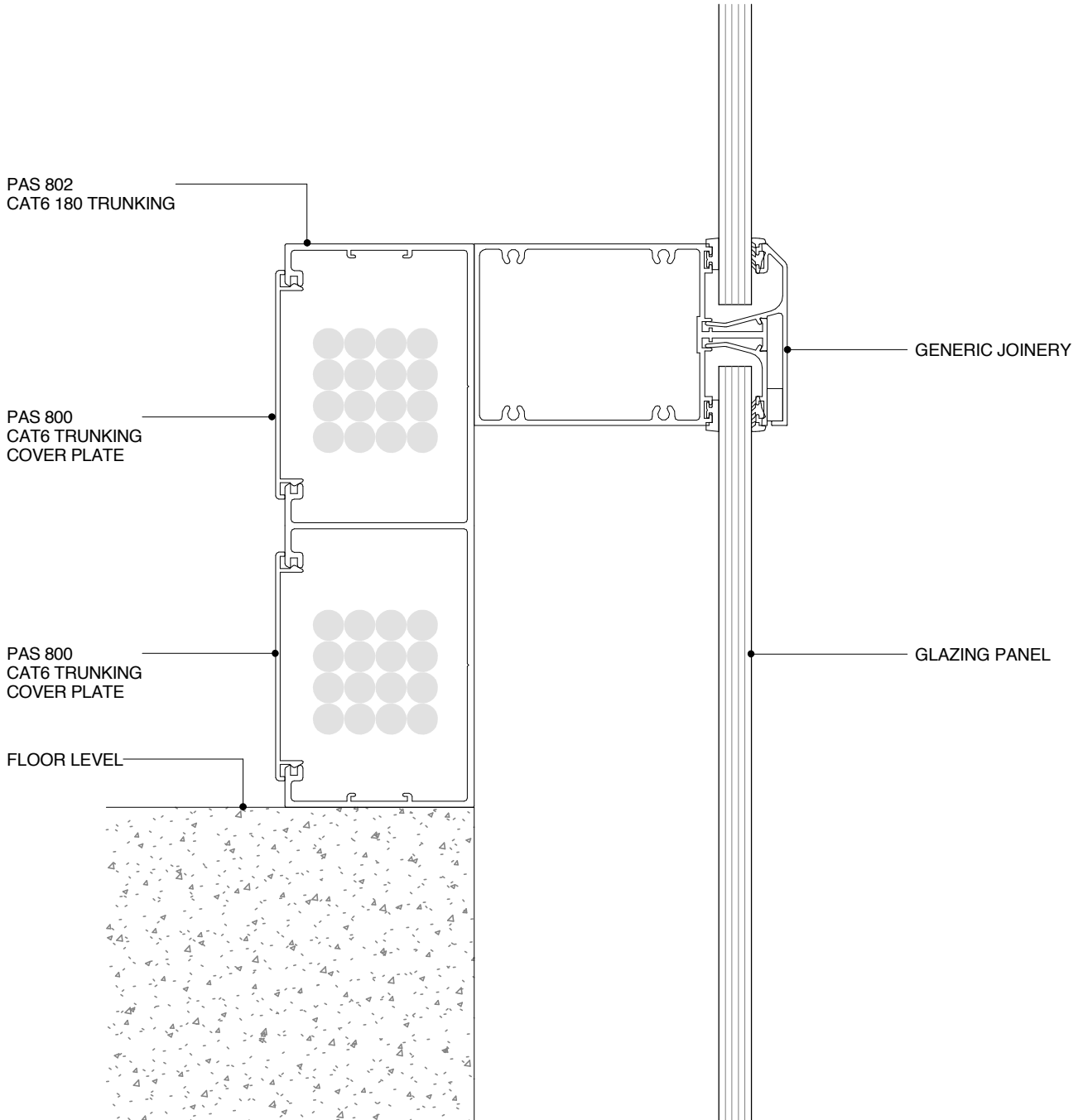

**POTTER ALUMINIUM SYSTEMS
T SERIES CAT 6 AT CURTAIN WALL FIXING**

CROSS SECTION

8.5.2
SHEET

1:2@A4
SCALE

A 23/05/16
ISSUED DATE

0800 POTTER (0800 768 837) WWW.POTTERS.CO.NZ
SUBJECT TO CHANGE WITHOUT NOTICE

