

**POTTER ALUMINIUM SYSTEMS
T SERIES - DETAIL REFERENCES**

8.3.1
SHEET

SCALE

A 01/04/2020
ISSUED DATE

0800 POTTER (0800 768 837) WWW.POTTERS.CO.NZ
SUBJECT TO CHANGE WITHOUT NOTICE



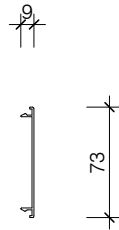

PAS 800
CAT6 TRUNKING
COVER PLATE

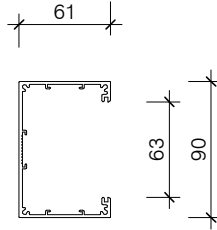

PAS801
CAT6 90 TRUNKING

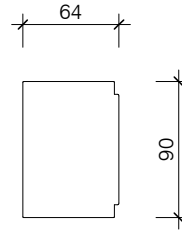

PASACC_ENDCAP801
CAT6 90 TRUNKING
END CAP

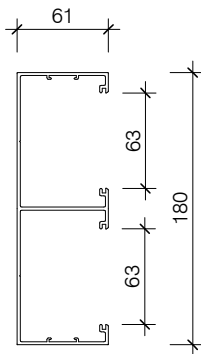

PAS 802
CAT6 180 TRUNKING

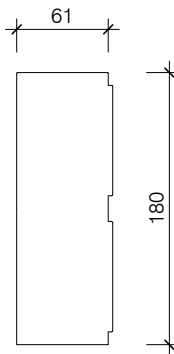

PASACC_ENDCAP802
CAT6 180 TRUNKING
END CAP

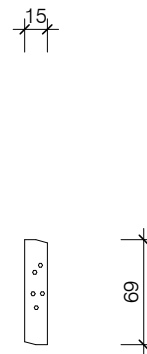

PASACC_CONNECTOR
TRUNKING
CONNECTOR

**POTTER ALUMINIUM SYSTEMS
T SERIES - SUITE PROFILES**

8.3.2
SHEET

1:5@A4
SCALE

A 01/04/2020
ISSUED DATE

0800 POTTER (0800 768 837) WWW.POTTERS.CO.NZ
SUBJECT TO CHANGE WITHOUT NOTICE



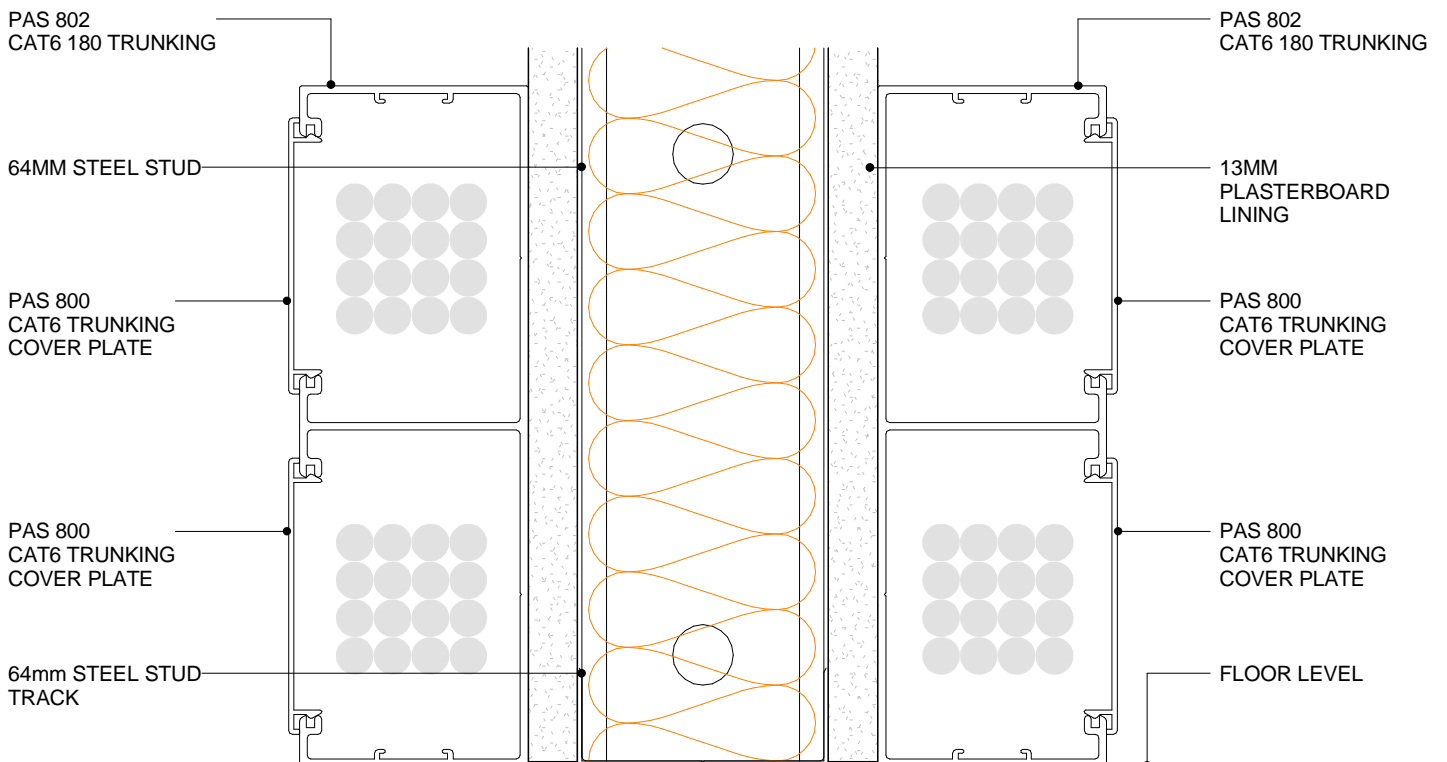
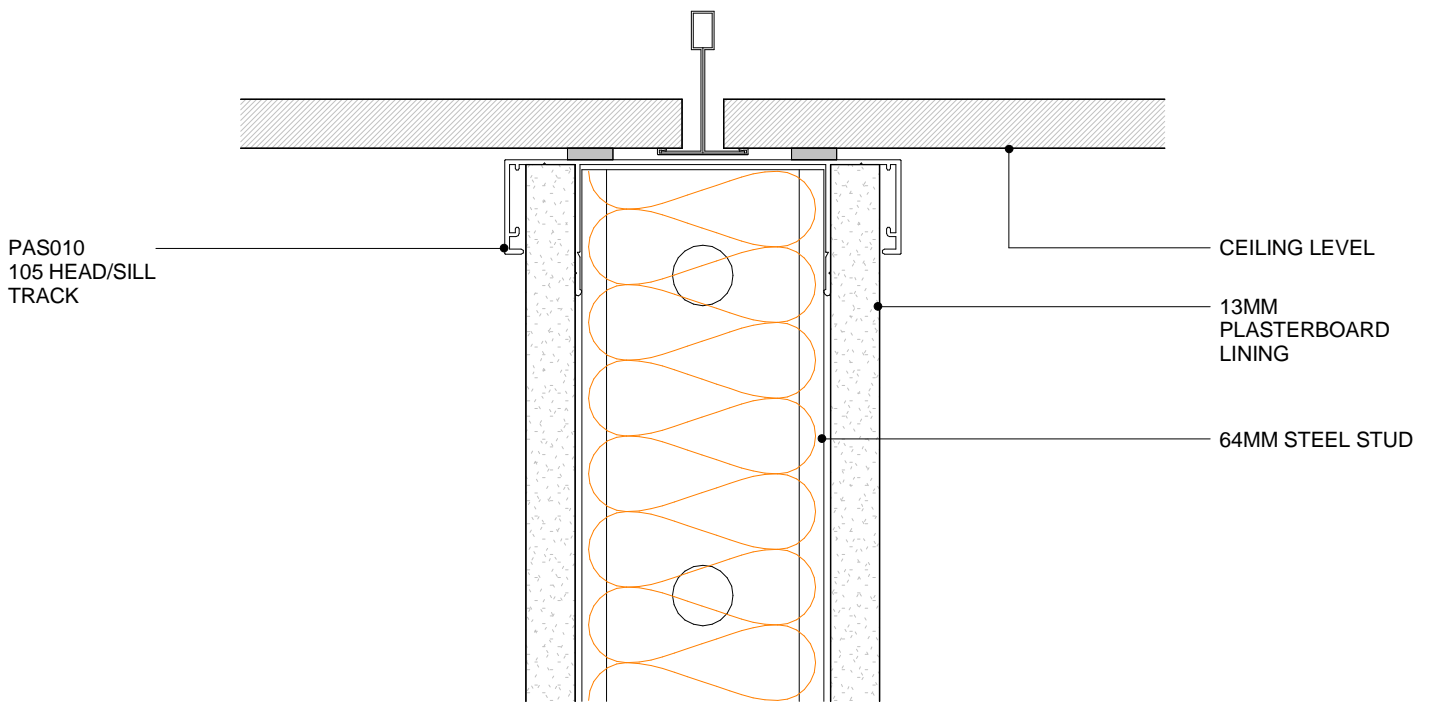

POTTER ALUMINIUM SYSTEMS
T SERIES - CAT 6 TWO SIDED SYSTEM ON PLASTERBOARD
CROSS SECTION

8.4.1
SHEET

1:2@A4
SCALE

A 01/04/2020
ISSUED DATE

0800 POTTER (0800 768 837) WWW.POTTERS.CO.NZ
SUBJECT TO CHANGE WITHOUT NOTICE



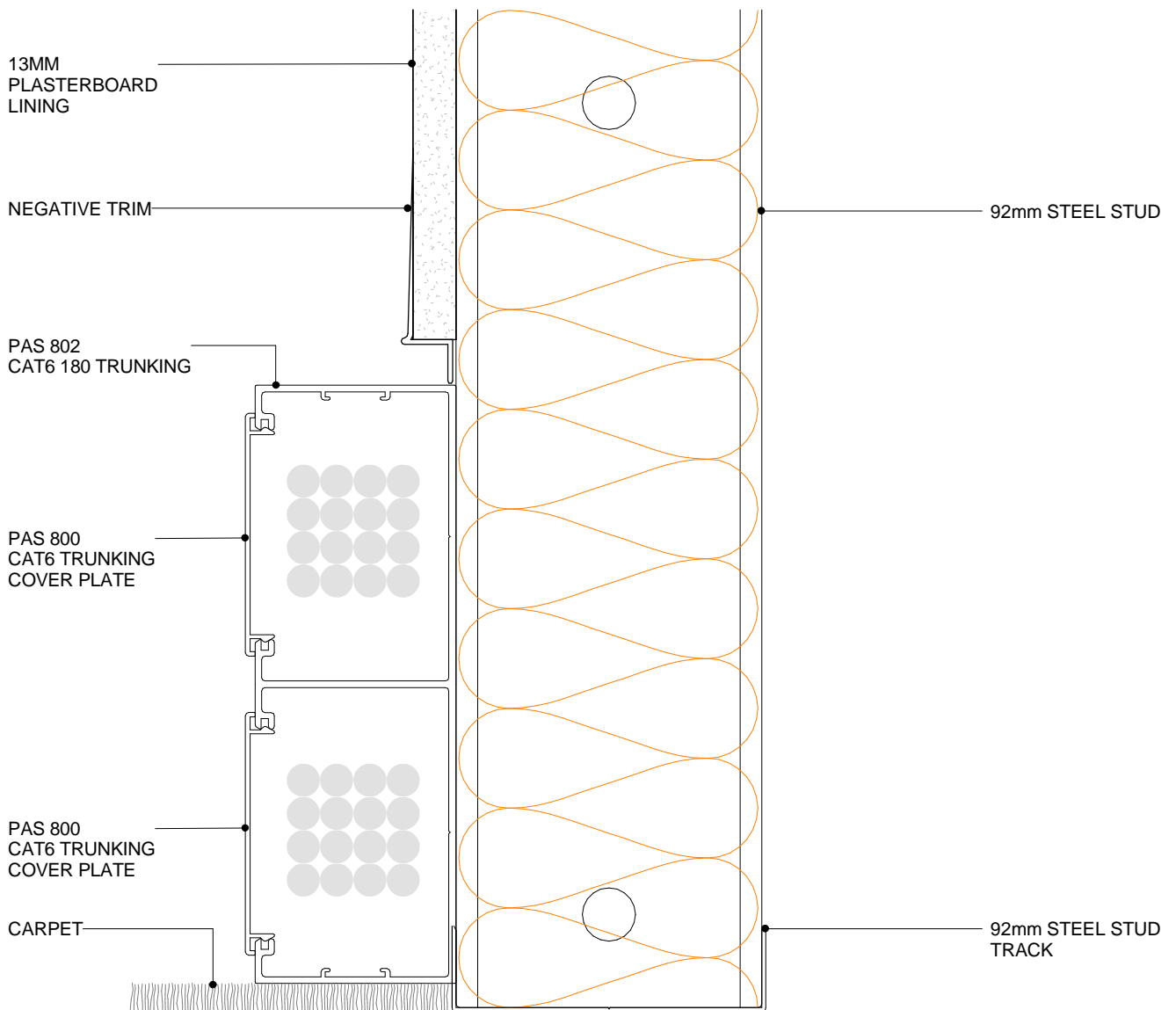

**POTTER ALUMINIUM SYSTEMS
T SERIES - CAT 6 ONE SIDED SYSTEM ON 92MM STEEL STUD
CROSS SECTION**

8.4.2
SHEET

1:2@A4
SCALE

A 01/04/2020
ISSUED DATE

0800 POTTER (0800 768 837) WWW.POTTERS.CO.NZ
SUBJECT TO CHANGE WITHOUT NOTICE



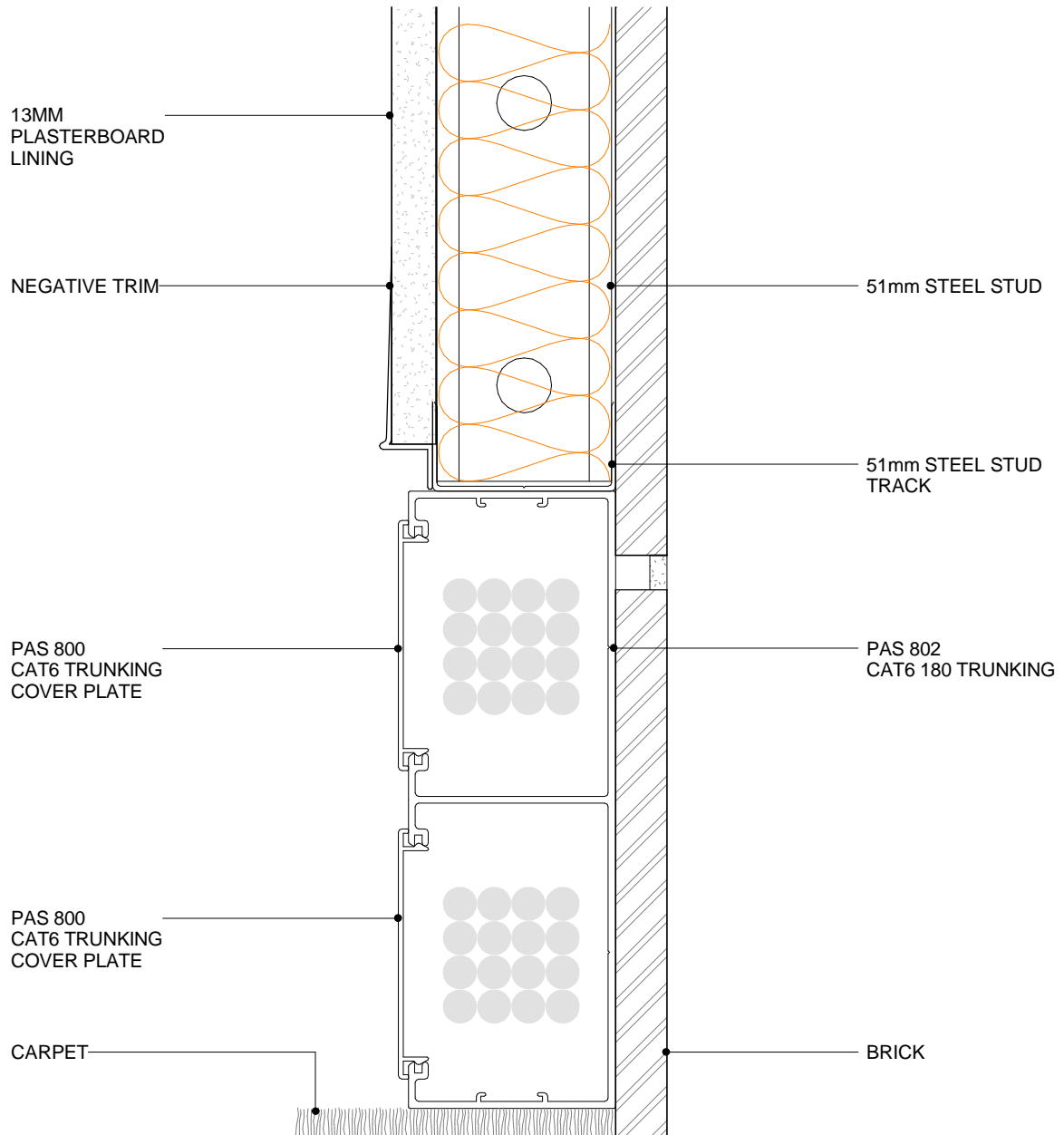

**POTTER ALUMINIUM SYSTEMS
T SERIES - CAT 6 ONE SIDE TRUNKING ON BRICK WALL
CROSS SECTION**

8.4.3
SHEET

1:2@A4
SCALE

A 01/04/2020
ISSUED DATE

0800 POTTER (0800 768 837) WWW.POTTERS.CO.NZ
SUBJECT TO CHANGE WITHOUT NOTICE

CSR

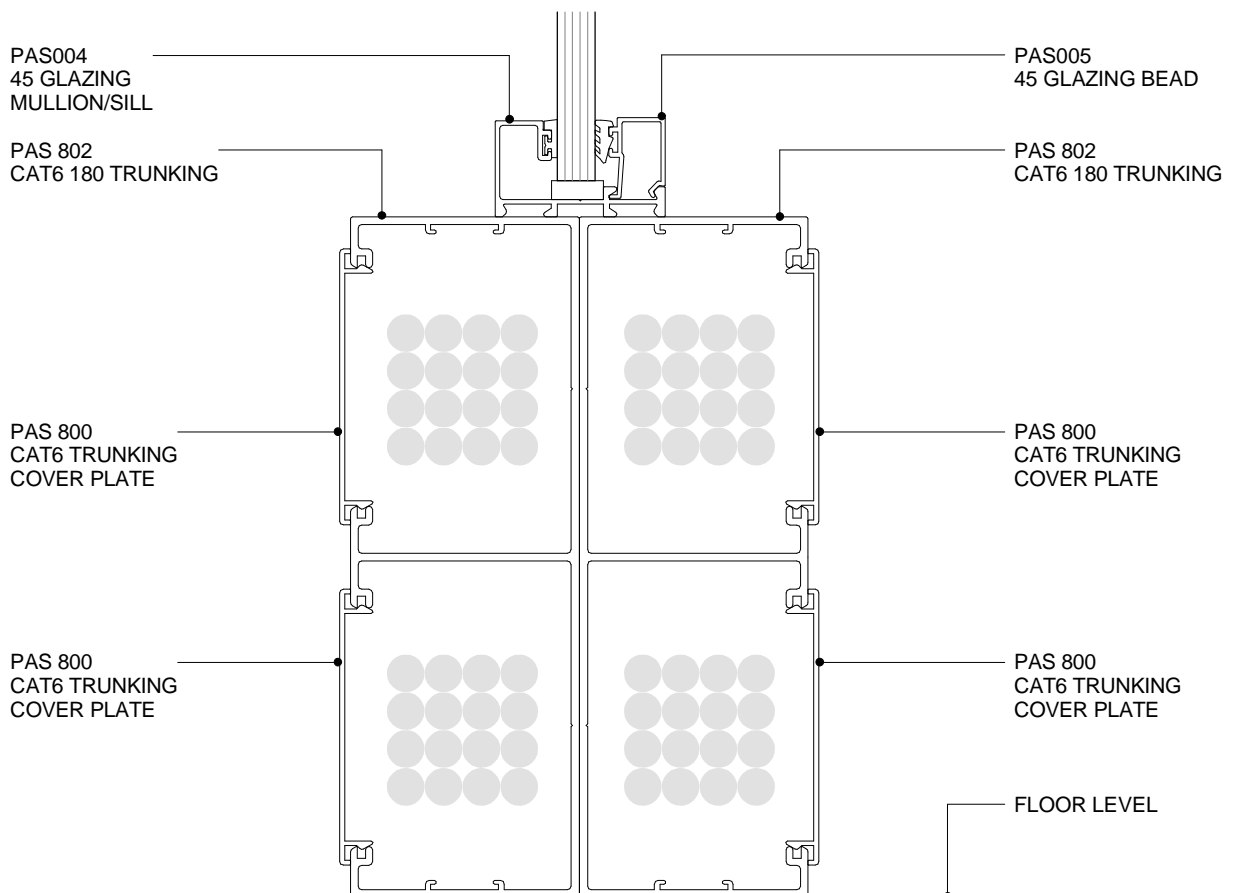
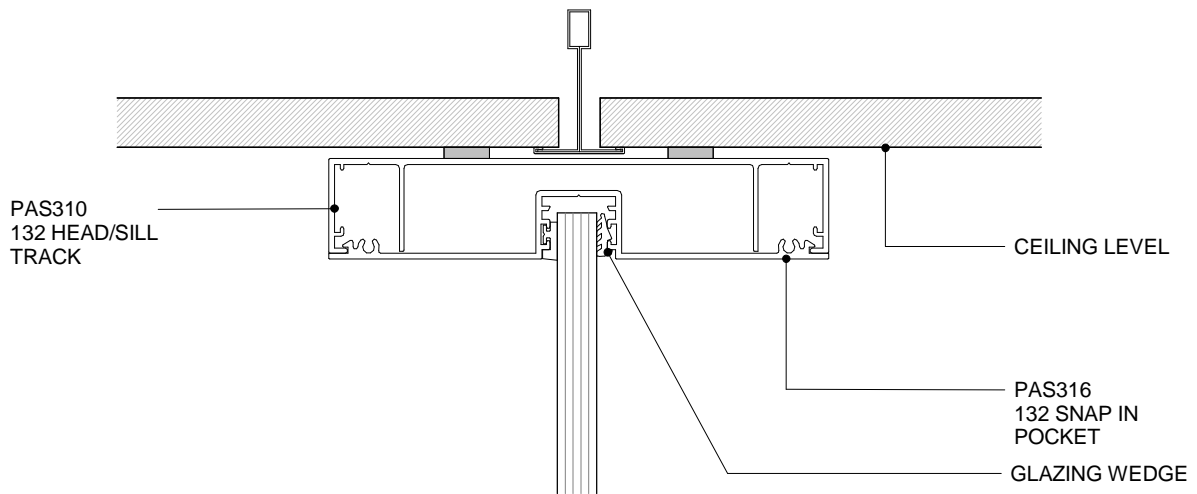

POTTER ALUMINIUM SYSTEMS
T SERIES - CAT 6 TWO-SIDED SYSTEM GLAZING 45MM
CROSS SECTION

8.4.4
SHEET

1:2@A4
SCALE

A 01/04/2020
ISSUED DATE

0800 POTTER (0800 768 837) WWW.POTTERS.CO.NZ
 SUBJECT TO CHANGE WITHOUT NOTICE



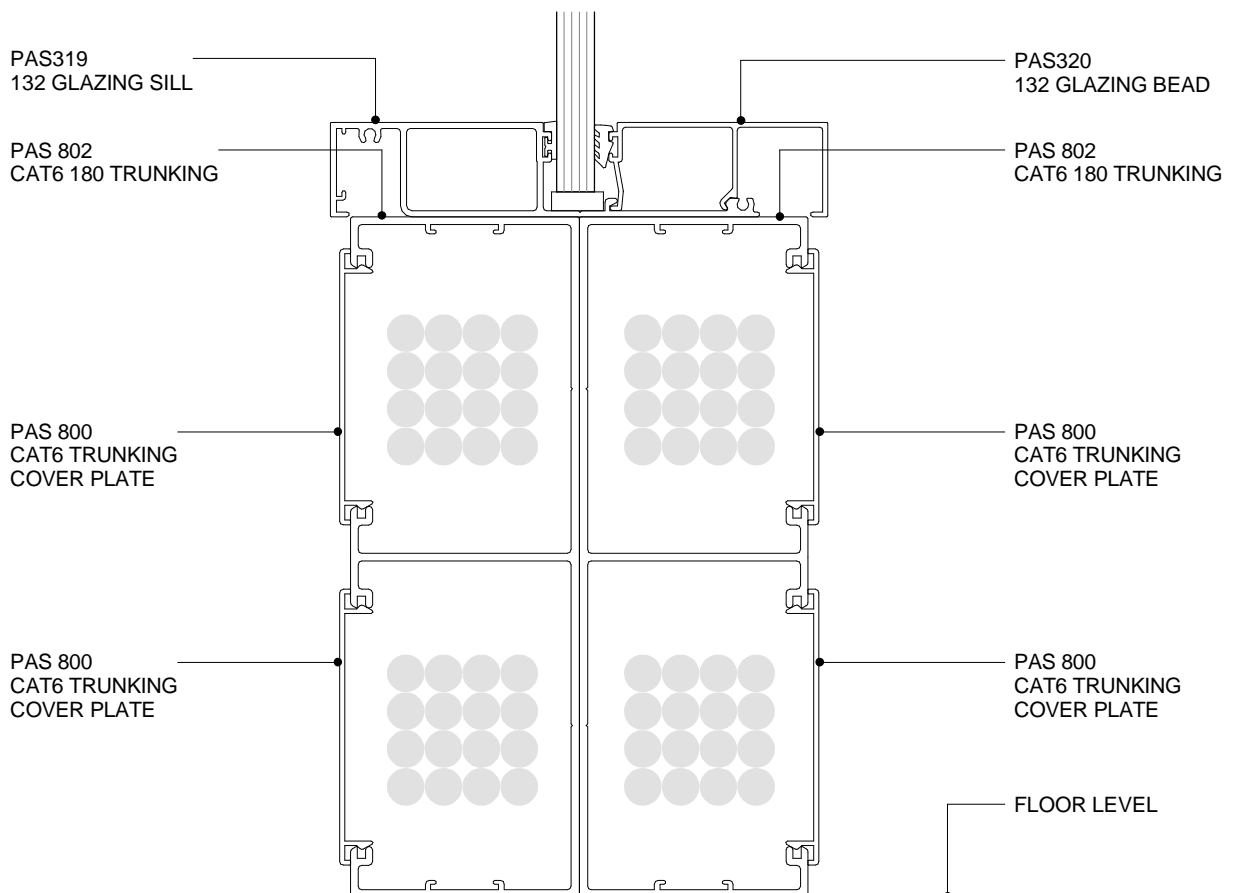
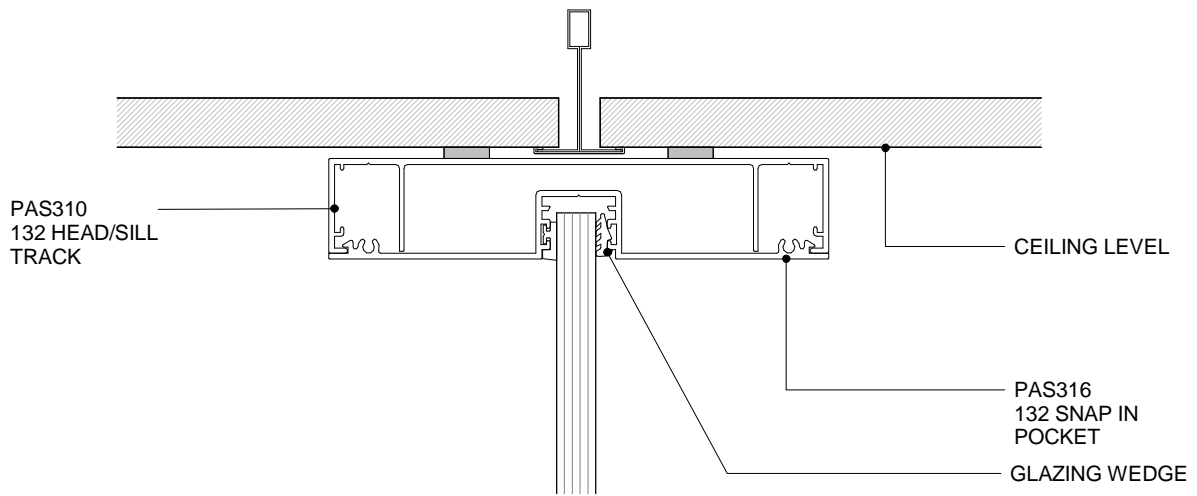

POTTER ALUMINIUM SYSTEMS
T SERIES - CAT 6 TWO-SIDED SYSTEM GLAZING 132
CROSS SECTION

8.4.5
SHEET

1:2@A4
SCALE

A 01/04/2020
ISSUED DATE

0800 POTTER (0800 768 837) WWW.POTTERS.CO.NZ
SUBJECT TO CHANGE WITHOUT NOTICE



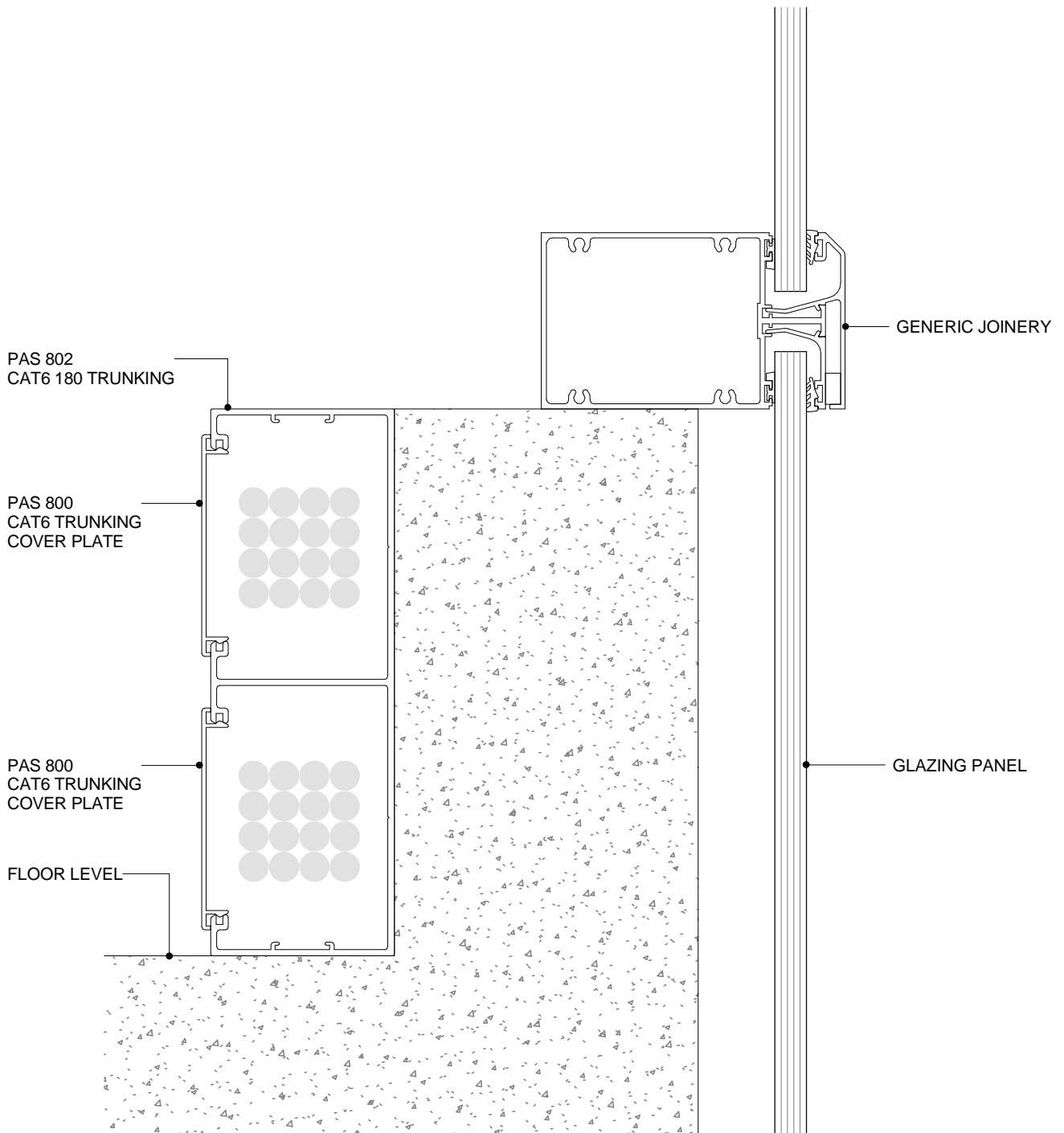

**POTTER ALUMINIUM SYSTEMS
T SERIES - CAT 6 AT CURTAIN WALL TO PRECAST FLOOR FIXING
CROSS SECTION**

8.5.1
SHEET

1:2@A4
SCALE

A 01/04/2020
ISSUED DATE

0800 POTTER (0800 768 837) WWW.POTTERS.CO.NZ
SUBJECT TO CHANGE WITHOUT NOTICE



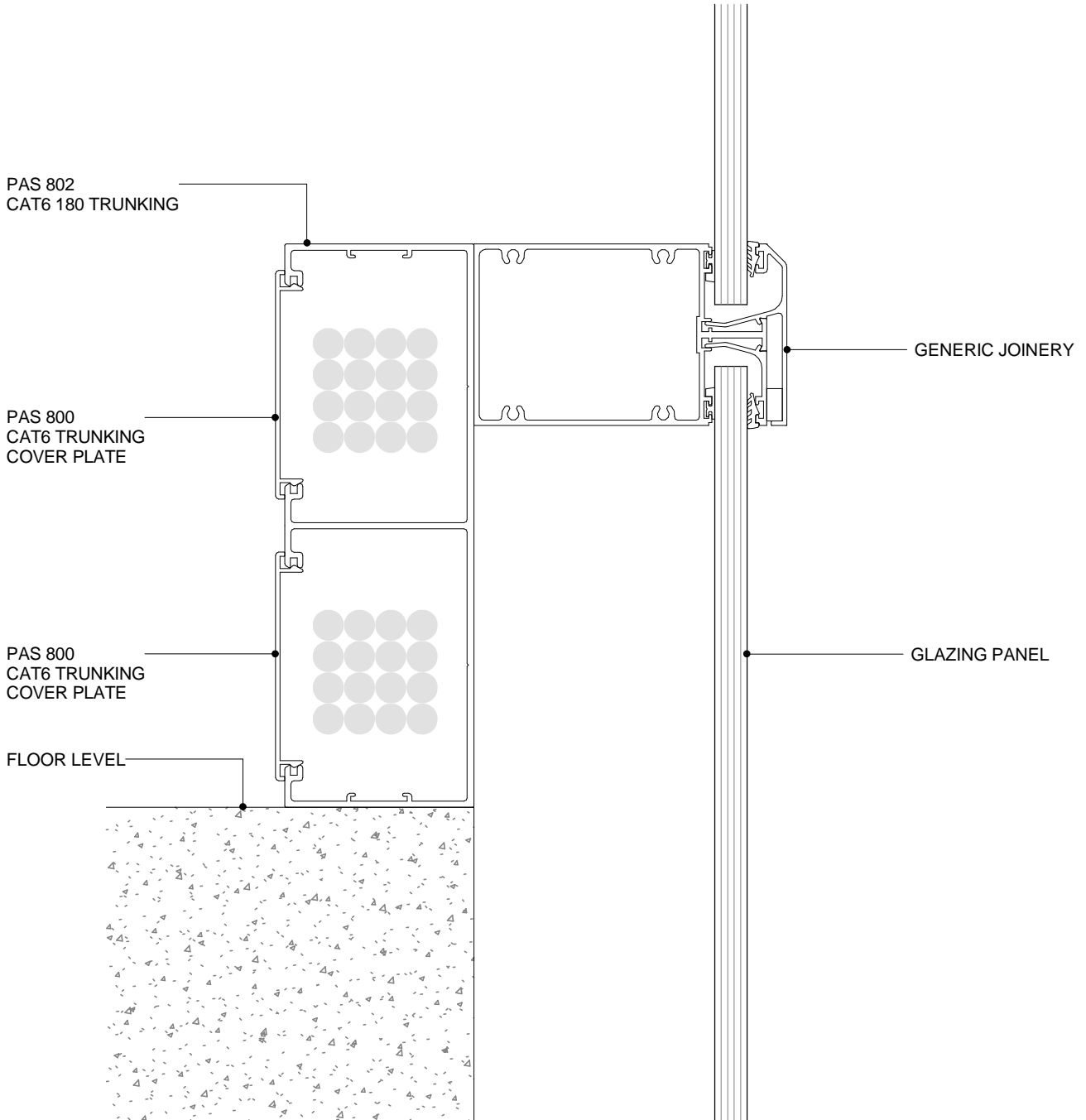

**POTTER ALUMINIUM SYSTEMS
T SERIES - CAT 6 AT CURTAIN WALL FIXING**

CROSS SECTION

8.5.2
SHEET

1:2@A4
SCALE

A 01/04/2020
ISSUED DATE

0800 POTTER (0800 768 837) WWW.POTTERS.CO.NZ
SUBJECT TO CHANGE WITHOUT NOTICE



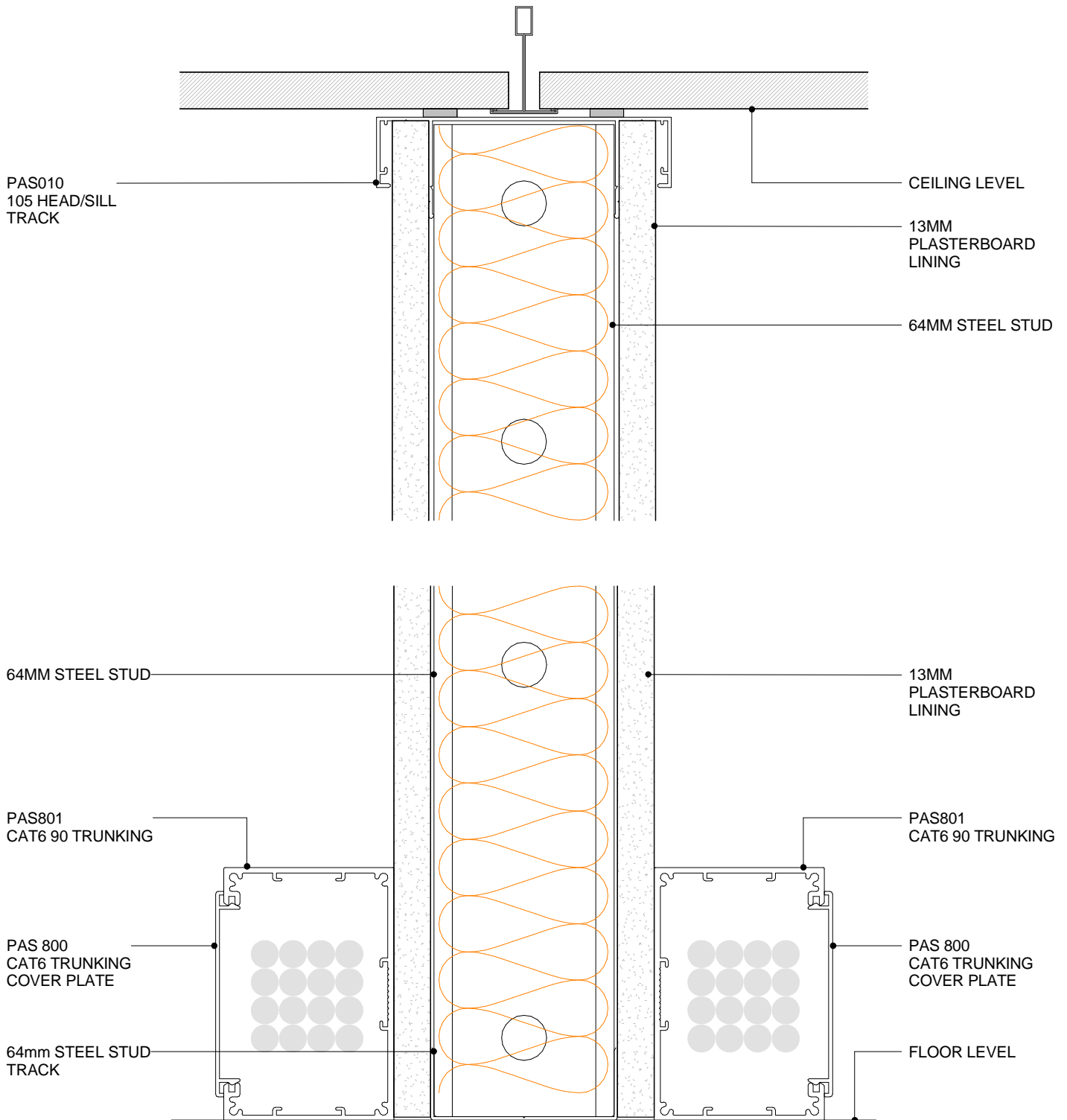

POTTER ALUMINIUM SYSTEMS
T SERIES - CAT 6 TWO SIDED SYSTEM ON PLASTERBOARD
CROSS SECTION

8.6.1
SHEET

1:2@A4
SCALE

A 01/04/2020
ISSUED DATE

0800 POTTER (0800 768 837) WWW.POTTERS.CO.NZ
SUBJECT TO CHANGE WITHOUT NOTICE



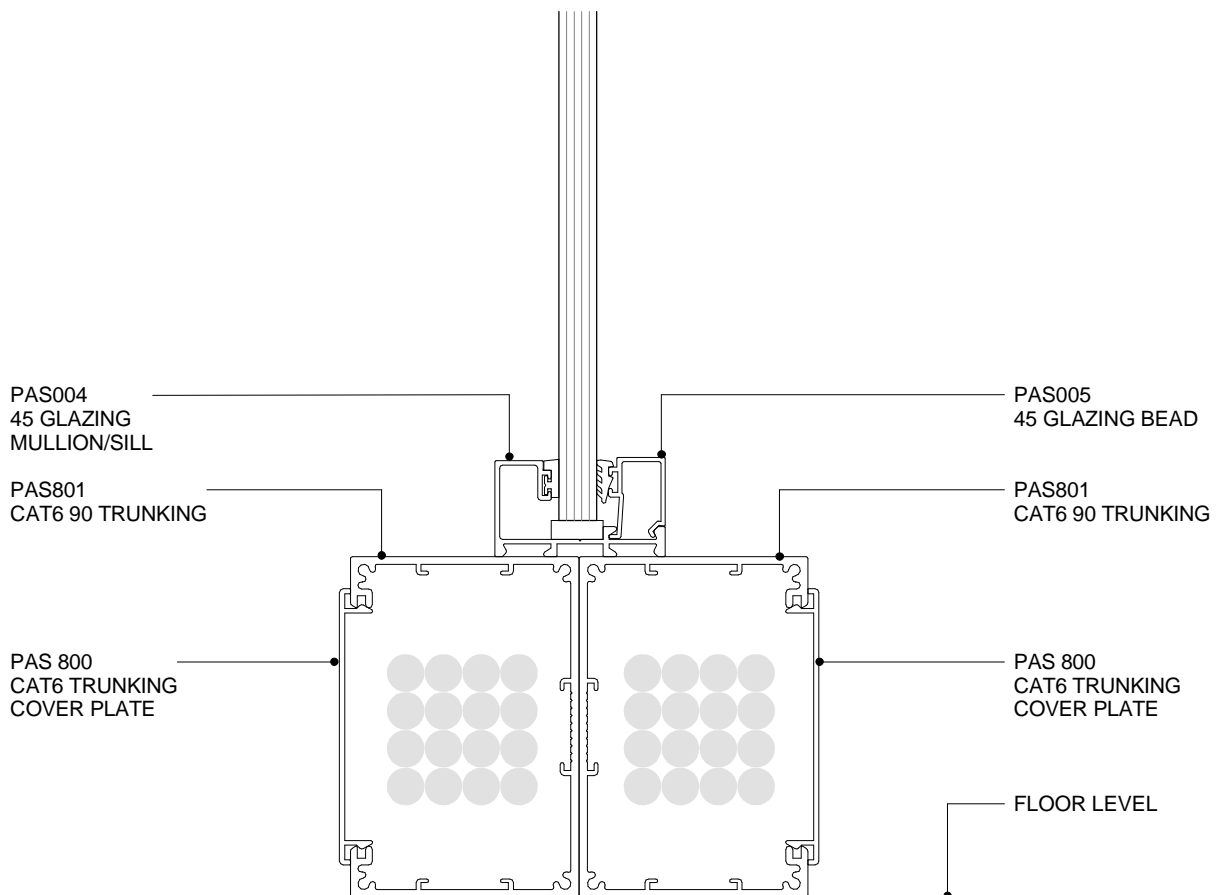
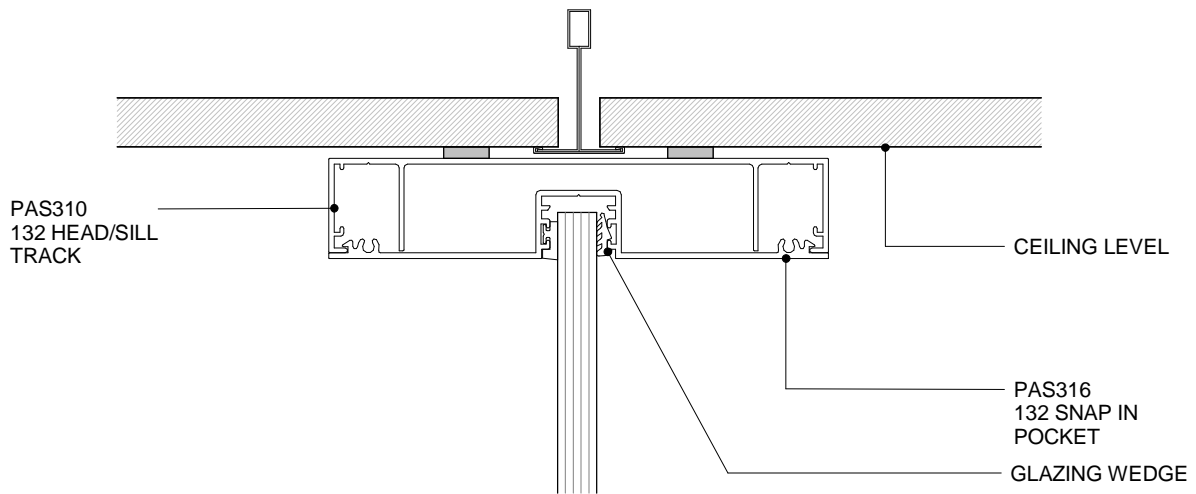

POTTER ALUMINIUM SYSTEMS
T SERIES - CAT 6 TWO SIDED SYSTEM GLAZING 45MM
CROSS SECTION

8.6.2
SHEET

1:2@A4
SCALE

A 01/04/2020
ISSUED DATE

0800 POTTER (0800 768 837) WWW.POTTERS.CO.NZ
 SUBJECT TO CHANGE WITHOUT NOTICE



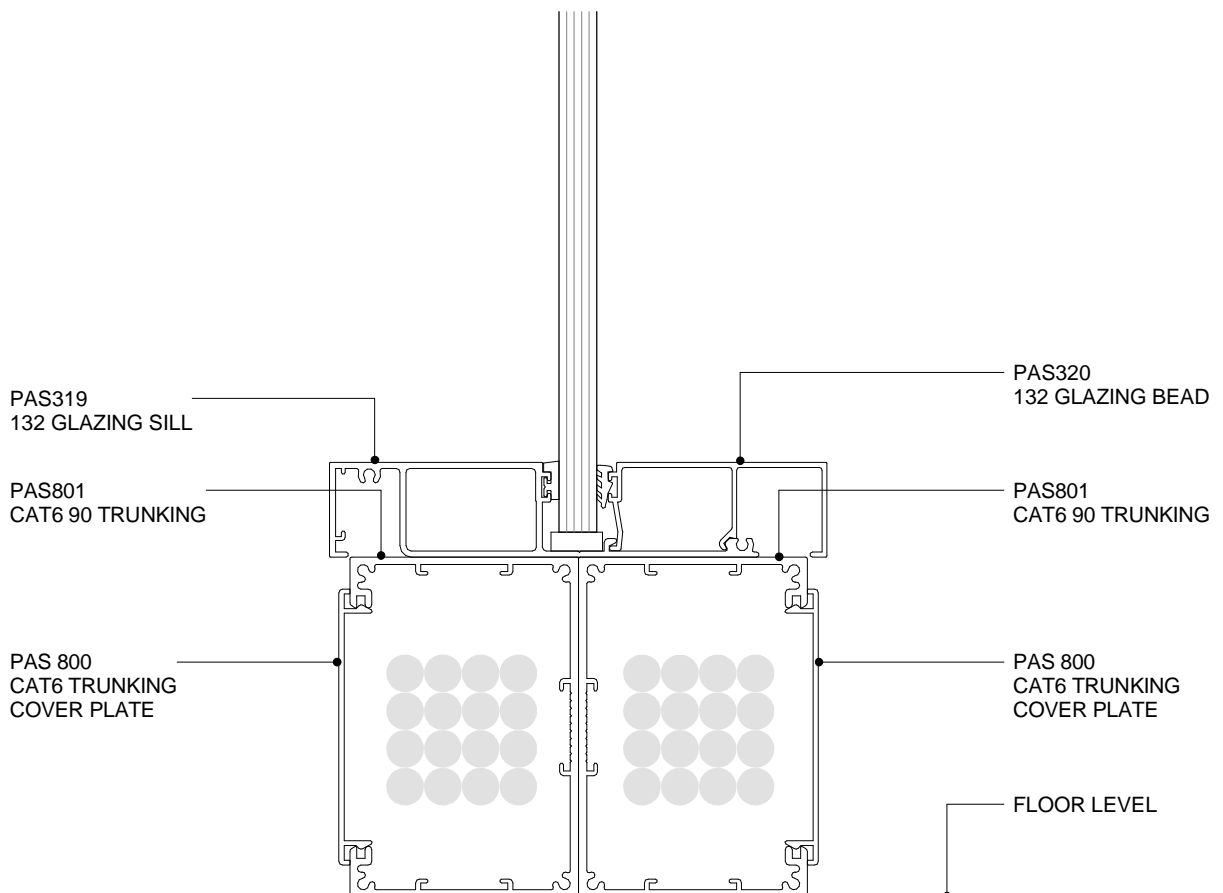
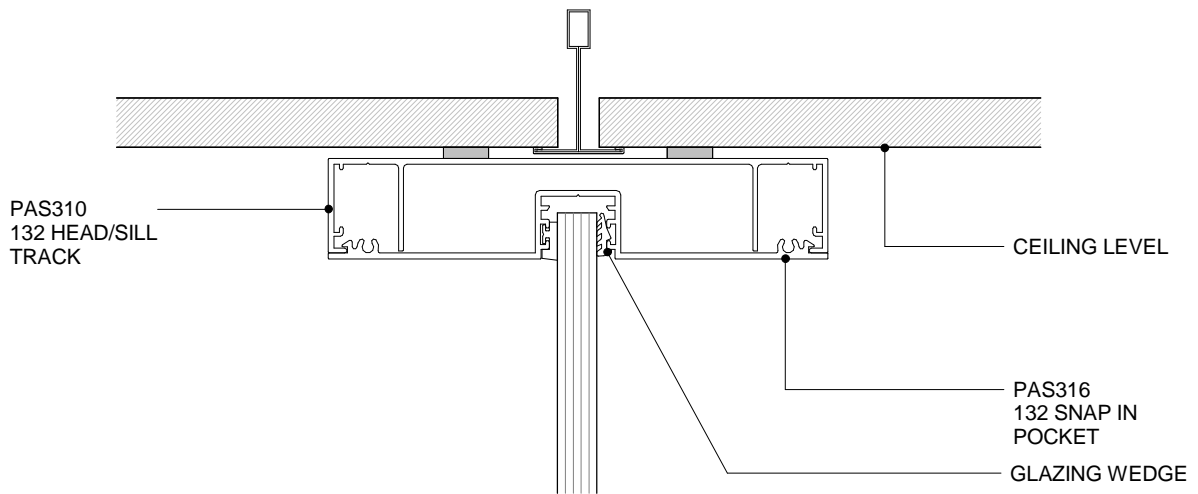

POTTER ALUMINIUM SYSTEMS
T SERIES - CAT 6 TWO SIDED SYSTEM GLAZING 132
CROSS SECTION

8.6.3
SHEET

1:2@A4
SCALE

A 01/04/2020
ISSUED DATE

0800 POTTER (0800 768 837) WWW.POTTERS.CO.NZ
 SUBJECT TO CHANGE WITHOUT NOTICE



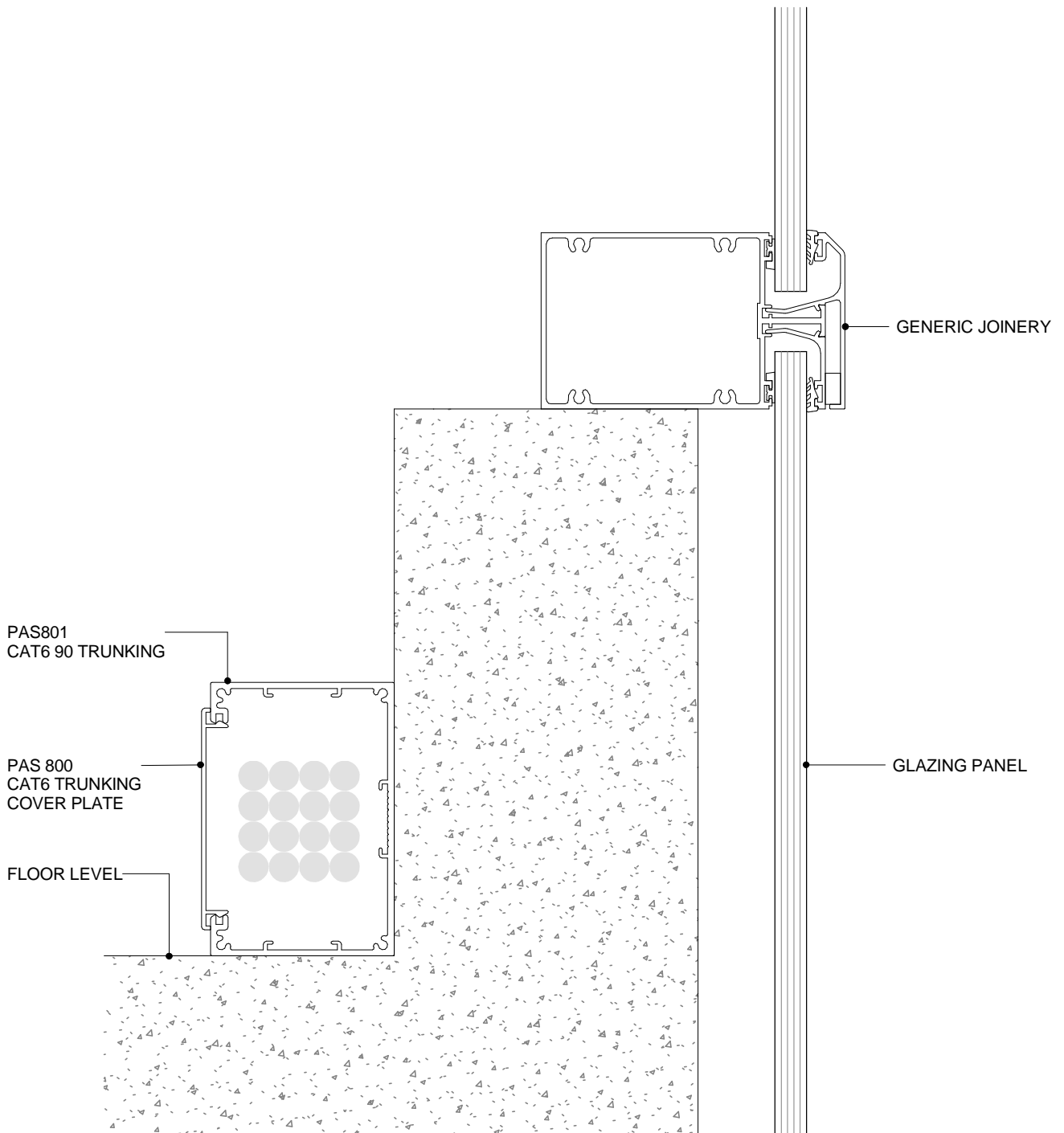

**POTTER ALUMINIUM SYSTEMS
T SERIES - CAT 6 AT CURTAIN WALL TO PRECAST FLOOR FIXING
CROSS SECTION**

8.6.4
SHEET

1:2@A4
SCALE

A 01/04/2020
ISSUED DATE

0800 POTTER (0800 768 837) WWW.POTTERS.CO.NZ
SUBJECT TO CHANGE WITHOUT NOTICE

