

RONDO
STEEL STUD
DRYWALL FRAMING SYSTEMS



INSTALLATION GUIDE

RONDO[®]

RONDO STEEL STUD & TRACK

DRYWALL FRAMING SYSTEMS

STEEL STUD & TRACK COMPONENTS

INTRODUCTION

Rondo Steel Stud Drywall Framing Systems provide designers with a versatile and durable framing system, manufactured to Australian and New Zealand Standards.

SUITABLE FOR

- Non-load and load bearing (by design) partition walls
- Steel Stud Ceiling Systems
- Window and Door Jambes
- Non-Fire Rated and Fire Rated Systems
- Acoustic Wall Systems (by design)
- External Wall systems (by design)
- Light Weight Floor Joists
- Bulkheads
- Seismic Wall System (by design)

SPECIAL FEATURES

- Available in custom lengths
- Majority of Stud and Track is hemmed for safety and increased strength, preventing unwanted rotation
- Flexible Track available for curved walls
- Manufactured from BlueScope Steel with a minimum coating of Z275
- Profile widths range from 51 to 150mm, and gauges from 0.50 to 1.15BMT.
- Includes unique QUIET STUD® profile for better acoustic performance
- Bell-mouthed service holes to mitigate damage to services

WHY USE RONDO STEEL STUD & TRACK

Designed to be not only stronger, but safer, our range of Hemmed Stud and Track sections help reduce handling injuries on site. The hemmed return lip increases rigidity, preventing unwanted rotation as well as eliminating sharp edges.

Rondo Steel Stud Drywall Framing Systems comply with all relevant Building Codes for fire-rated, acoustic, seismic and load-bearing requirements.

The availability of various sizes, complementary components such as nogging tracks, curved tracks and special cleats ensures Rondo Stud and Track Wall Systems are available to suit almost all situations, such as internal drywall partitions up to 10 metres in height, depending on the application.

Note that this brochure is intended to be used as a guide only; full details should be obtained via the Rondo website. Rondo recommends installation by a qualified tradesperson and that you ensure you are referring to the latest version of this guide by comparing it to the one on our website. Installation of complex or load-bearing wall systems should be undertaken by a qualified tradesperson.

The details in this brochure may not be suitable for fire-rated or acoustic applications, and Rondo recommends consulting a suitably qualified professional.

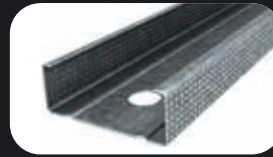

WALL STUD

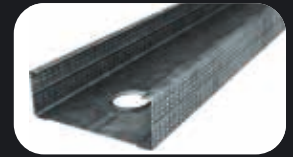

HEMMED STUD



QUIET STUD®



DUPLEX STUD®



HEMMED WALL TRACK



HEMMED DEFLECTION HEAD TRACK



NOGGING BRACKET

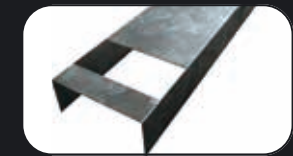

NOGGING TRACK



SNAP-LOCK NOGGING®



FAST-FIX NOGGING®



FLEXIBLE TRACK



545

RONDO STEEL STUD & TRACK

INSTALLATION DETAILS

1 SYSTEM SELECTION

Using Table 1 below, choose the stud appropriate to your wall height and the lining board you desire to use. Then select tracks to match size and gauge of chosen studs.

2 SET OUT AND INSTALLATION

Install the floor and ceiling track to suit your wall layout and secure to the structure at no less than 600mm centres internally, and 100mm from ends. For information on the appropriate fixings, consult your Rondo Network Partner.

3 INSERT WALL STUDS

Insert Wall Studs into Wall Tracks at the appropriate position, ensuring all studs are facing the same way. Wall studs are designed to be friction fitted into the tracks, and are installed using a twisting action. Ensure service holes in studs are aligned. Studs are braced by the application of the lining board, so do not require permanent fixing.

4 INTERSECTIONS

Figures 1 & 2 show typical wall intersections whilst Figures 4 & 5 show typical ceiling intersections. For more complex connections, refer to the Rondo website or consult your Rondo Network Partner.

5 CONTROL JOINTS

Plasterboard manufacturers recommend control joints be installed in continuous walls at not more than 12m. Refer Figure 3.

6 PLASTERBOARD LINING

While plasterboard manufacturers should be consulted about linings, it is critical that lining boards be installed to the open side of the stud first to ensure misalignment of joints does not occur in vertical fixing applications.

TABLE 1: MAXIMUM WALL HEIGHTS

PLASTERBOARD LININGS		SINGLE STUDS @ 600mm CENTRES							
		BMT		0.50		0.55		0.75	
STUD WIDTH		51mm	64mm	76mm	92mm	64mm	76mm	92mm	
LINED BOTH SIDES	1x10mm	2770	3330	3700	4540	3930	4430	4830	
	1x13mm	3200	3720	4130	4940	4220	5020	5500	
	1x16mm	3380	3910	4300	5180	4350	5250	5710	
LINED ONE SIDE	1x10mm	2320	2720	3200	3610	3130	3580	4130	
	1x13mm	2320	2720	3240	3610	3250	3820	4180	
	1x16mm	2320	2720	3250	3610	3280	3870	4200	

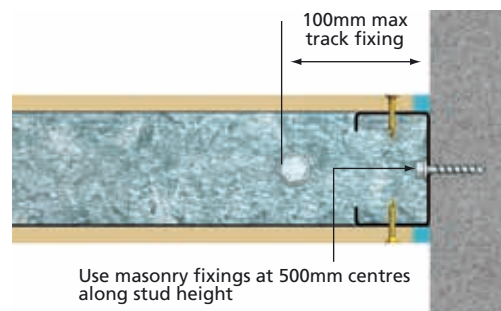

FIGURE 1: INTERSECTION – MASONRY

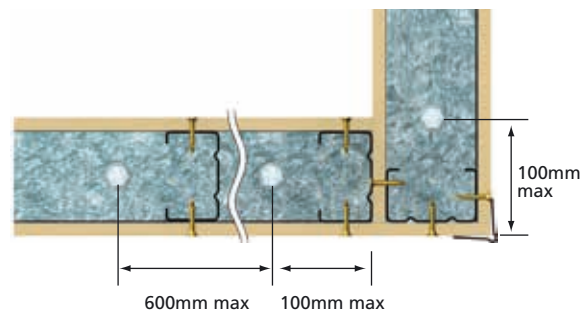

FIGURE 2: CORNER – SINGLE LAYER APPLICATION

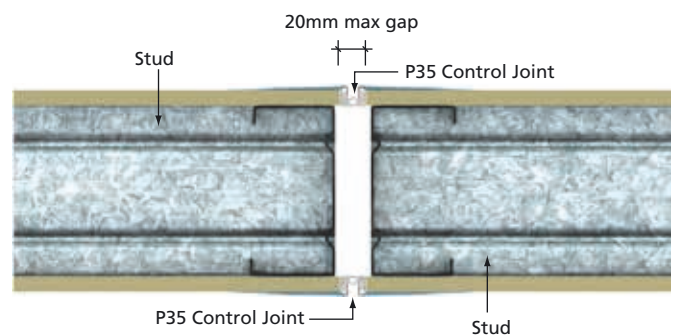

FIGURE 3: STUD WALL CONSTRUCTION WITH CONTROL JOINT

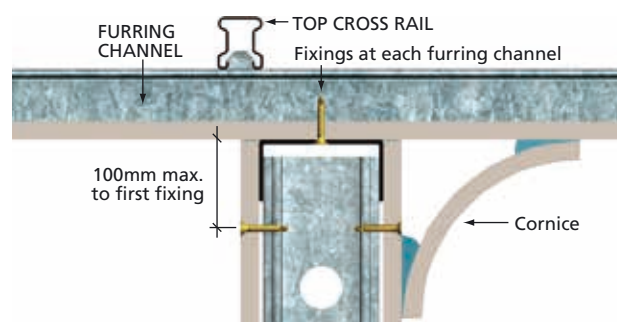

FIGURE 4: WALL/CEILING INTERSECTION DETAIL WITH FRICTION FIT FOR CORNICE APPLICATIONS

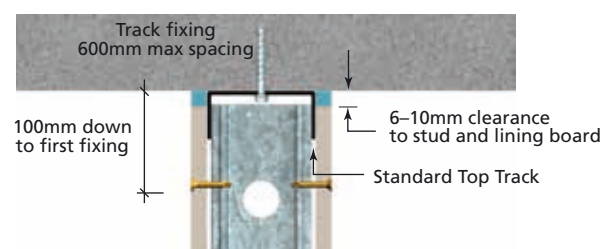

FIGURE 5: FRICTION FIT APPLICATION

NOTE: DO NOT RIGIDLY FIX CORNICE TO WALLS WHERE FRICTION JOINTS OR DEFLECTION HEADS ARE USED.

WINDOW & DOOR FRAMING

Figure 6 details standard fixings suitable for window openings up to 1500mm and standard single leaf door openings. For configurations outside of these limits and external wall framings, consult your local Rondo office.

NOTE:

- Studs adjacent to window and door openings should be boxed and screw-fastened to the bottom wall track. Alternatively, use the one-piece DUPLEX Stud® fixed in the same manner.
- Allow sufficient length on each end of the track to facilitate a suitable connection at the head or sill.
- Fit studs above and below the window openings and above the door openings as per Detail A.

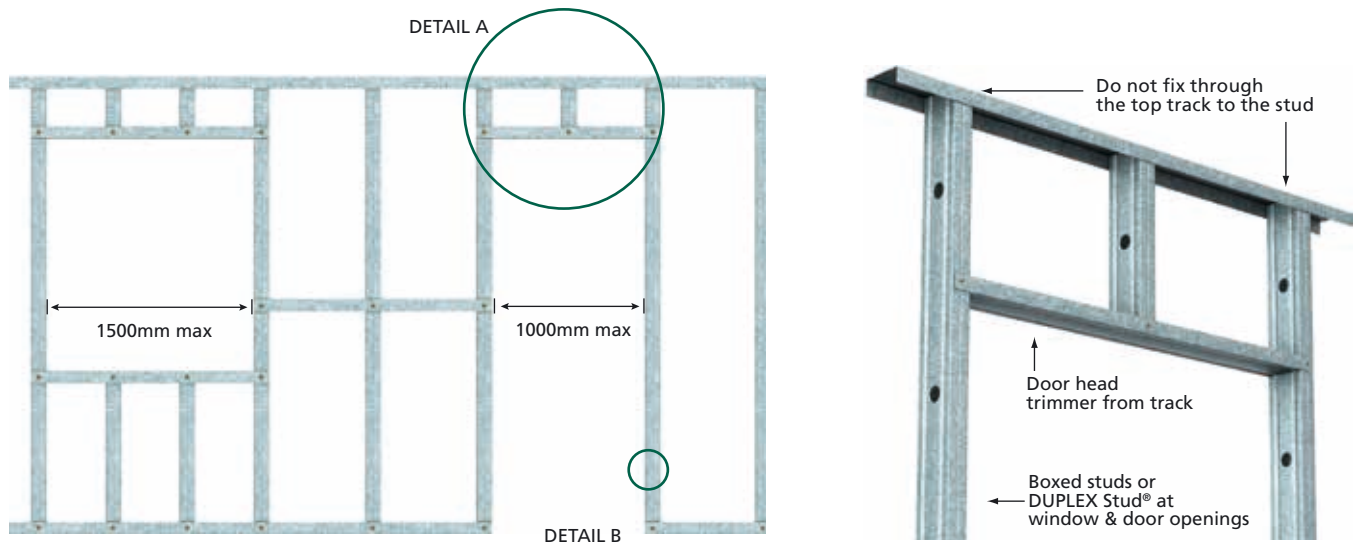

■ FIGURE 6: INTERNAL WALL FRAMING

■ DETAIL A: DOOR/WINDOW HEAD DETAIL

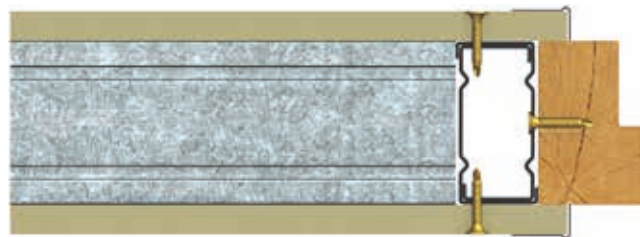

Timber Door Jamb with Stopping Bead to Lining Board

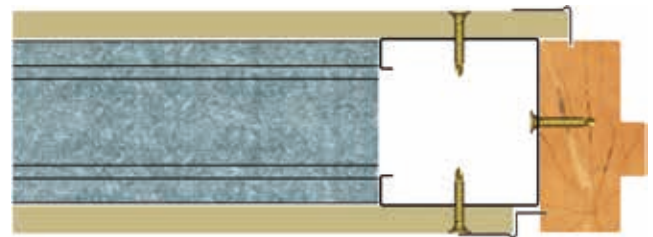

Typical detail for timber door frame secured to DUPLEX Stud® with optional shadowline detail shown

■ DETAIL B: VARIOUS DOOR JAMB DETAILS

NOGGINGS

Rondo produces three different noggings for steel stud walls. One is installed whilst the framing is being constructed and the other two after the framing is complete. All are available to suit stud centres of 300, 400, 450 & 600mm.

The requirement for noggings in your wall can be determined by Table 2.

TABLE 2: MINIMUM NUMBER OF NOGGINGS

WALL HEIGHT (m)	LINING CONDITION	NUMBER OF NOGGINGS
0 – 4.4	BOTH SIDES	0
4.4 – 8.8		1
0 – 3.0	LINED ONE SIDE	1
3.0 – 6.0		2
6.0 – 8.0		3
8.0+		4

NOTE: Walls connected to the underside of a concrete slab must be installed with deflection head track and an additional row of Noggings 100mm down if unlined, or lined one side only.

For more complex technical details, view the Rondo Professional Design Manual or speak to a stockist in our Rondo Partner Network. Download a copy of the Manual and locate a Rondo Partner by visiting our website. For board fixing details, please see the plasterboard manufacturer.

STANDARD NOGGING TRACK

This is laid over the top of the floor track and once the studs are placed in the punched slots in the track, it is slid up into place and screwed, both sides, to the studs, usually at the mid-point with #8 wafer or lost head screws.

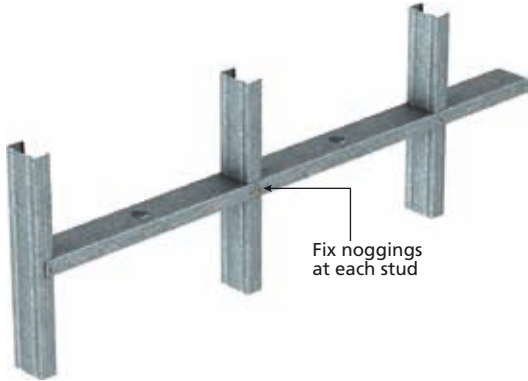

■ FIGURE 7: STANDARD NOGGING TRACK DETAILS

SNAP-LOCK NOGGING®

The Rondo SNAP-LOCK Nogging® is designed for use with Rondo 0.50 and 0.55bmt lightweight studs. SNAP-LOCK clips into the bellmouth service holes in a continuous, overlapping manner *after* the framing is installed. It is important to ensure the service holes align vertically.

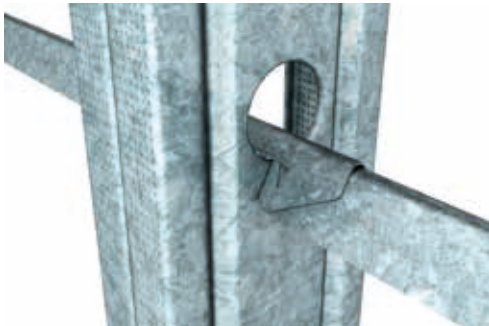

■ FIGURE 8: OVERLAPPING OF SNAP-LOCK NOGGING® WHEN CONTINUOUS

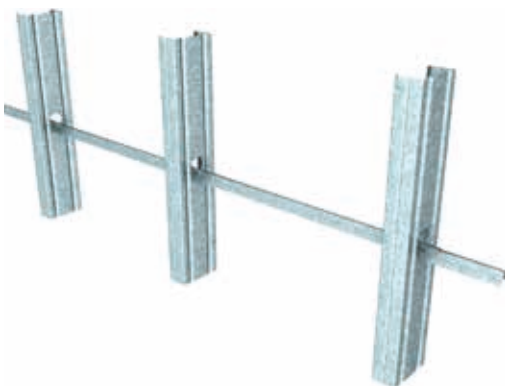

■ FIGURE 9: CONTINUOUS INSTALLATION OF SNAP-LOCK NOGGING® BETWEEN RONDO STEEL STUDS

FAST-FIX NOGGING®

This is also installed *after* the framing is complete. The primary fixing method is to use the bend out tab as shown in Figure 10, the tab being scored at the bend points, and screw fixed with a #8 wafer or lost head screw. However, for simple full height stud walls lined both sides or one side, the face fix method can be used as shown in Figure 11.

These noggings are not used continuously but are staggered, one up one down as shown in Figure 12.

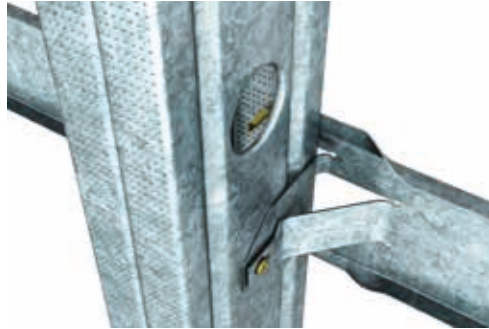

■ FIGURE 10: BACK VIEW OF TAB/FACE FIX x 3 SCREWS INSTALLATION METHOD

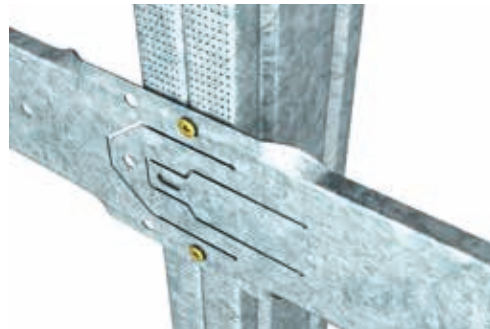

■ FIGURE 11: FAST-FIX NOGGING® INSTALLED INTO RONDO STEEL STUD USING FACE-FIX x 2 SCREWS METHOD

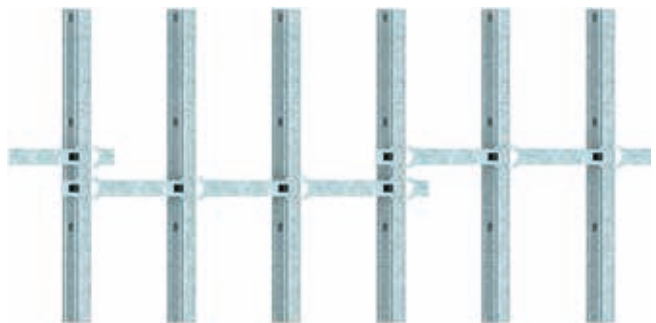

■ FIGURE 12: FAST-FIX NOGGING® INSTALLATION

For more detailed information on Rondo Noggings, refer to the Nogging Manual on our website, or speak to a reseller in our Rondo Partner Network.

RONDO SERVICES

MUCH MORE THAN JUST QUALITY PRODUCTS

We go beyond supplying you with quality products. We give you access to a full suite of tools and services to help you get the job done right and with the confidence that we'll support you every step of the way.

- ✓ **TECHNICAL SUPPORT** We offer expert technical advice from our team of professional Engineers and Technical Representatives who can support you from beginning concepts all the way through to building completion.
- ✓ **WRITTEN WARRANTY** Our products are 100% code compliant and we guarantee that they'll perform to our exacting specifications with a written warranty to give you added peace of mind.
- ✓ **PRODUCT QUALITY** Our state-of-the-art manufacturing technology ensures you receive the highest quality product, with most of our roll-formed products manufactured from the strength of BlueScope Steel.
- ✓ **QUALITY CONTROL** We have a reputation for uncompromising quality and total code compliance. Our certification to internationally recognised, Lloyd's Register Quality Assurance ISO 9001 is evidence of this.
- ✓ **DELIVERY SERVICE** We offer a reliable and efficient delivery service, with products delivered in full and on time whether it is on site or to store.
- ✓ **TECHNICAL RESOURCES** We've developed market-leading technical resources that are available in print and digitally to help you get the job done.
- ✓ **REPUTATION** It's our reputation for high-quality products backed by exceptional customer service that has led to us being behind the best buildings around the world. It's a reputation you can rely on.
- ✓ **ENVIRONMENTAL PERFORMANCE** We can offer you additional Green Points due to our participation in the Environmental Sustainability Charter and our Environmental Management System is accredited to ISO14001.
- ✓ **CORPORATE SOCIAL RESPONSIBILITY** Through purchasing Rondo products, you are also supporting local communities we give back to. We're focused to help kids with cancer, with our main partner, The Kids Cancer Project. Their goal is to reduce the rate of childhood cancer through funded research initiatives.

RONDO[®]
www.rondo.com.au

RONDO, QUIET STUD, DUPLEX STUD, FAST-FIX NOGGING and SNAP-LOCK NOGGING are registered trademarks of Rondo Building Services Pty Ltd. ABN 69 000 289 207.

First Printed MAY 2009. Revised JUNE 2020.