

TIPS FOR ARCHITECTS AND DESIGNERS:
TYPICAL FOR ALL SUITES

- 6MM - 13MM MAXIMUM LAMINATED GLASS SIZE
- 13MM PLASTERBOARD ONLY
- 105MM PROFILES = 64MM STUD
- 132MM PROFILES = 92MM STUD
- SD = SINGLE/DOUBLE ACOUSTIC WALL LININGS
- DD = DOUBLE/DOUBLE ACOUSTIC WALL LININGS
- FOR SOUND TRANSMISSION CLASS POINTS (STC) REFER TO THE POTTERS WEBSITE WWW.POTTERS.CO.NZ IN THE "PARTITIONING" SECTION

POTTER ALUMINIUM SYSTEMS
E SERIES 132 - DETAIL REFERENCES

9.3.1
SHEET

SCALE

A 01/04/2020
ISSUED DATE

0800 POTTER (0800 768 837) WWW.POTTERS.CO.NZ
SUBJECT TO CHANGE WITHOUT NOTICE

CSR

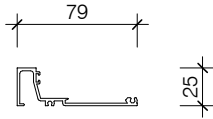

PAS033
105 EDGE GLAZING
FRAME

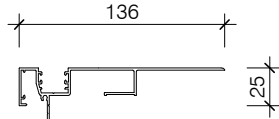

PAS313/E
ADJUSTABLE MULTI
TRACK E

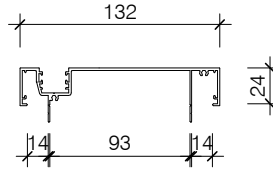

PAS332
132 OFFSET
GLAZING FRAME

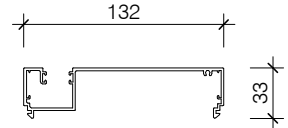

PAS332/D
132 DEEP POCKET
GLAZING FRAME

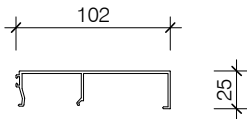

PAS334
132 EDGE GLAZING
BEAD

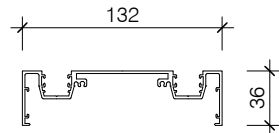

PAS335
132 TWIN GLAZING
MULLION FRAME

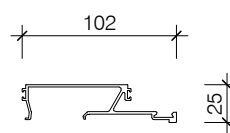

PAS336
132 TWIN GLAZING
BEAD

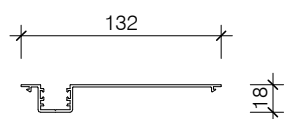

PAS338
132 OFFSET GLAZE
SNAP IN POCKET

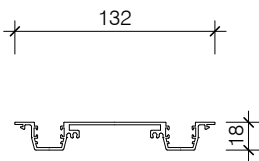

PAS339
132 TWIN GLAZE
SNAP IN POCKET

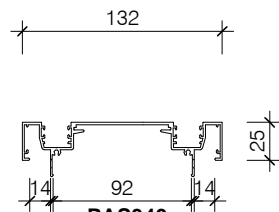

PAS340
132 TWIN GLAZING
FRAME

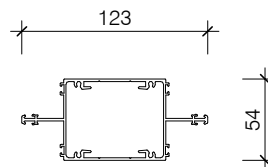

PAS341
TWIN GLAZING
TRANSOM

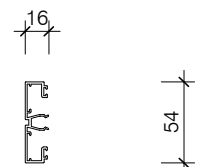

PAS342
TWIN GLAZING
TRANSOM BEAD

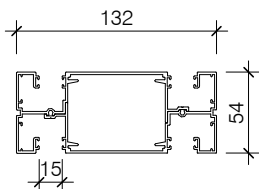

PAS343
TWO PIECE TWIN
GLAZE MULLION

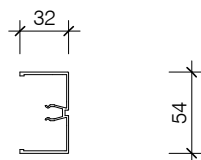

PAS344
132 SINGLE GLAZING
TRANSOM BEAD

**POTTER ALUMINIUM SYSTEMS
E SERIES 132 - SUITE PROFILES**

9.3.2
SHEET

1:5@A4
SCALE

A 01/04/2020
ISSUED DATE

0800 POTTER (0800 768 837) WWW.POTTERS.CO.NZ
SUBJECT TO CHANGE WITHOUT NOTICE

CSR

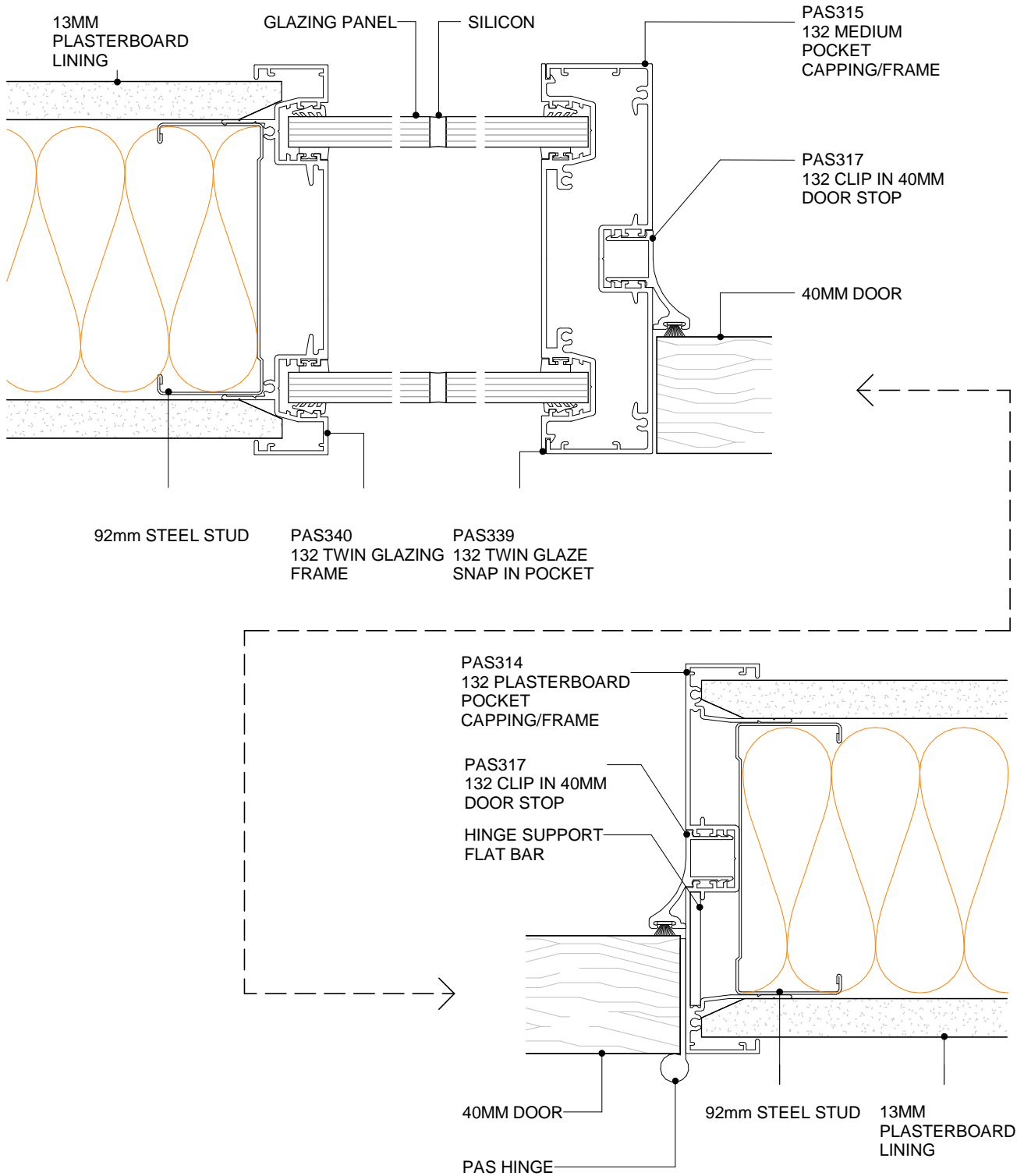

POTTER ALUMINIUM SYSTEMS
E SERIES 132 - 92MM - MULLION & DOOR WALL SECTION
PLAN VIEW

9.4.1
SHEET

1:2@A4
SCALE

A 01/04/2020
ISSUED DATE

0800 POTTER (0800 768 837) WWW.POTTERS.CO.NZ
SUBJECT TO CHANGE WITHOUT NOTICE



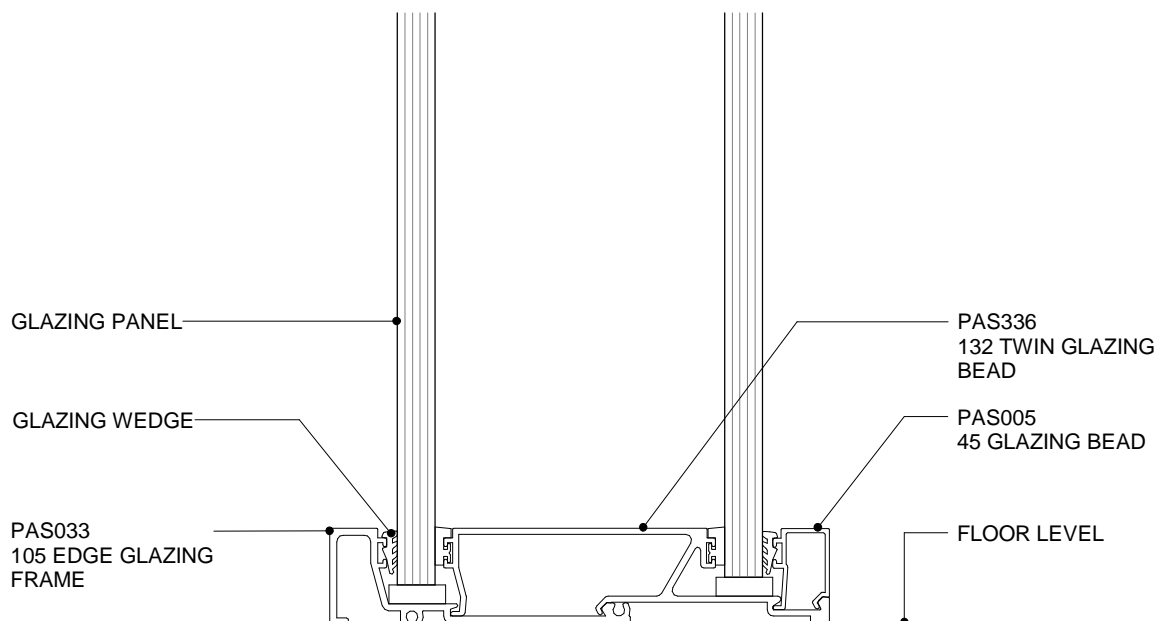
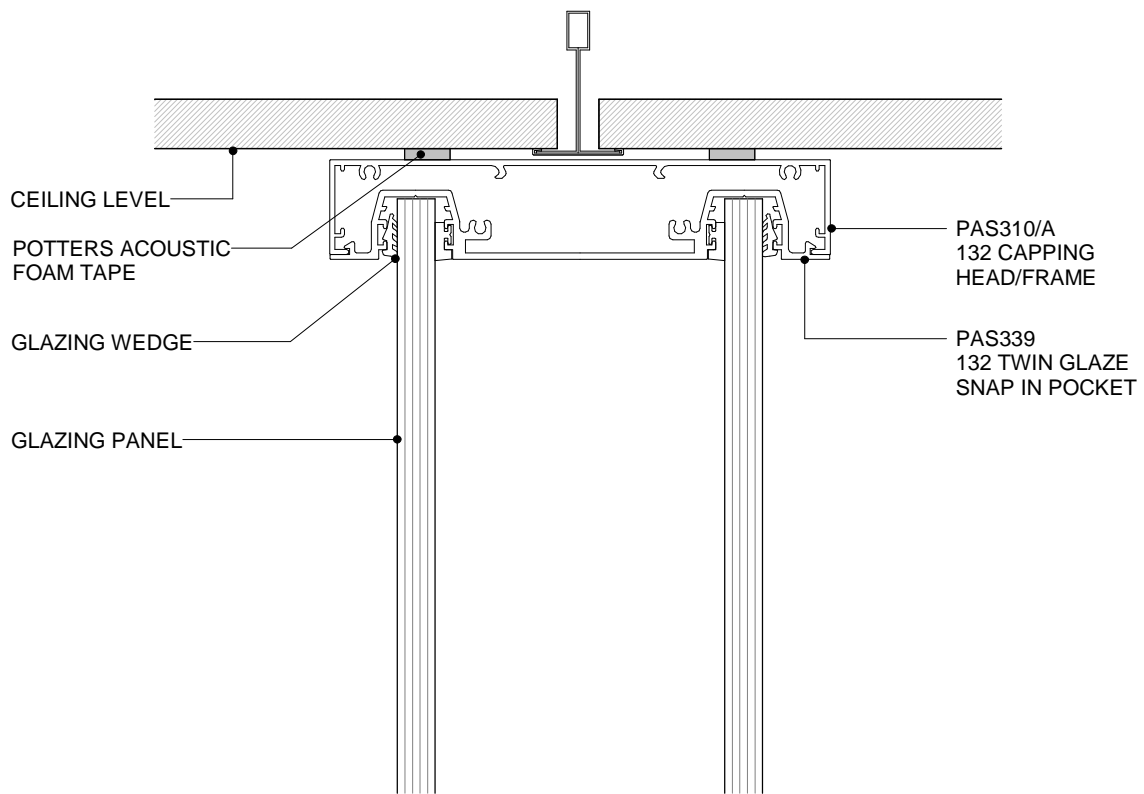

**POTTER ALUMINIUM SYSTEMS
E SERIES 132 - TWIN GLAZING WALL**

CROSS SECTION

9.4.2
SHEET

1:2@A4
SCALE

A 01/04/2020
ISSUED DATE

0800 POTTER (0800 768 837) WWW.POTTERS.CO.NZ
SUBJECT TO CHANGE WITHOUT NOTICE



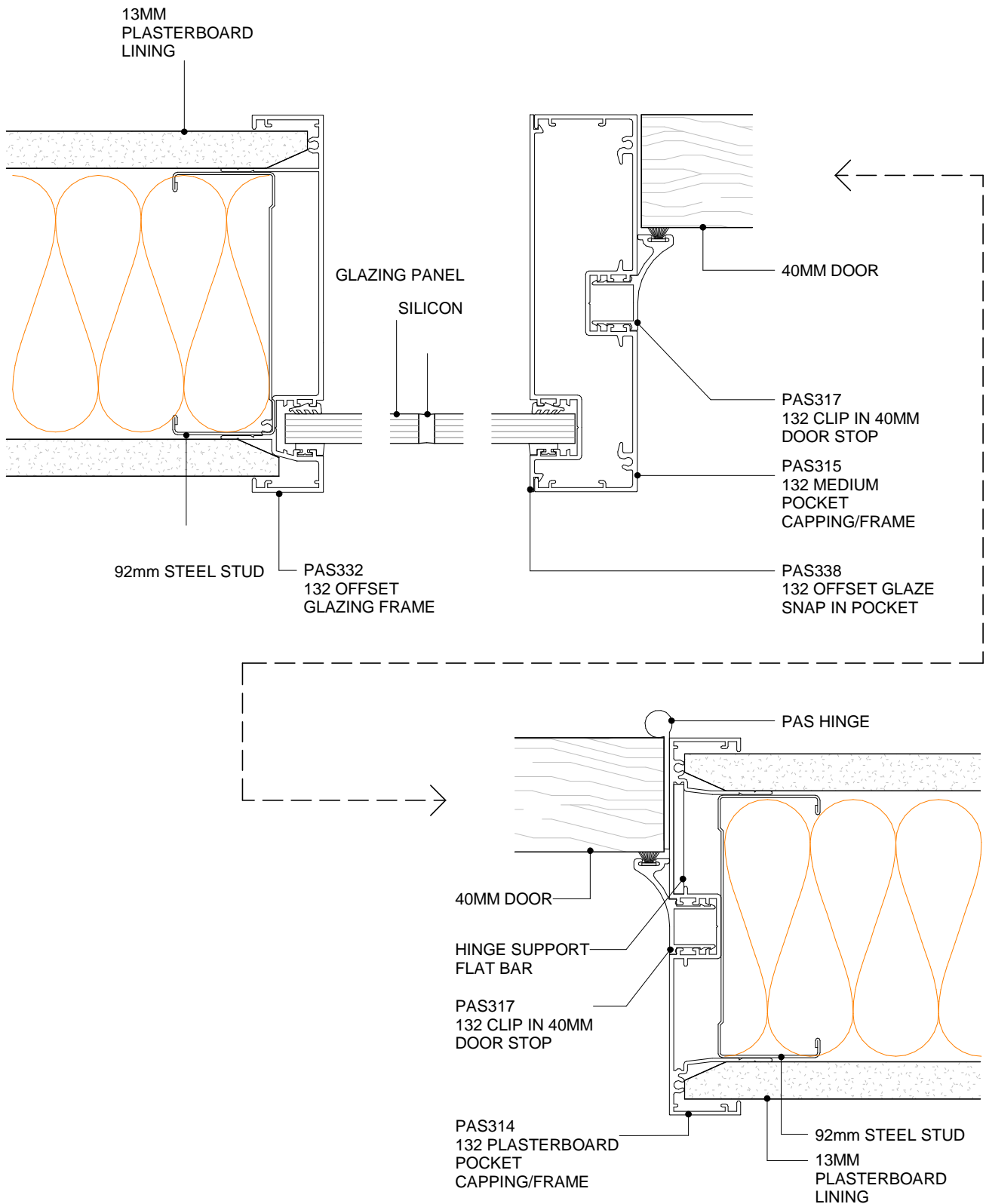

POTTER ALUMINIUM SYSTEMS
E SERIES 132 - 92MM MULLION & DOOR WALL
PLAN VIEW

9.4.3
SHEET

1:2@A4
SCALE

A 01/04/2020
ISSUED DATE

0800 POTTER (0800 768 837) WWW.POTTERS.CO.NZ
SUBJECT TO CHANGE WITHOUT NOTICE



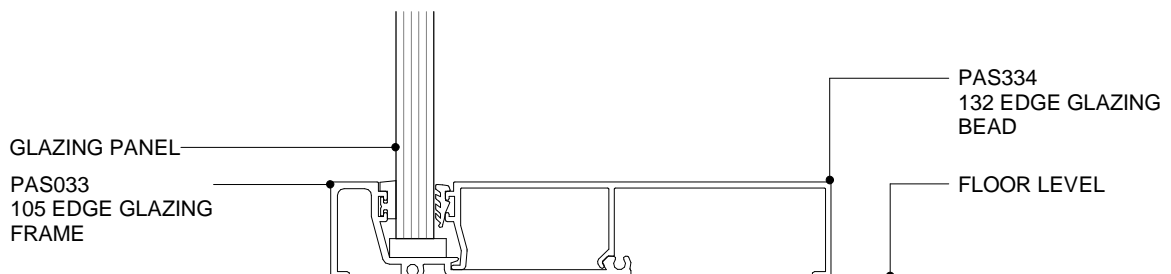
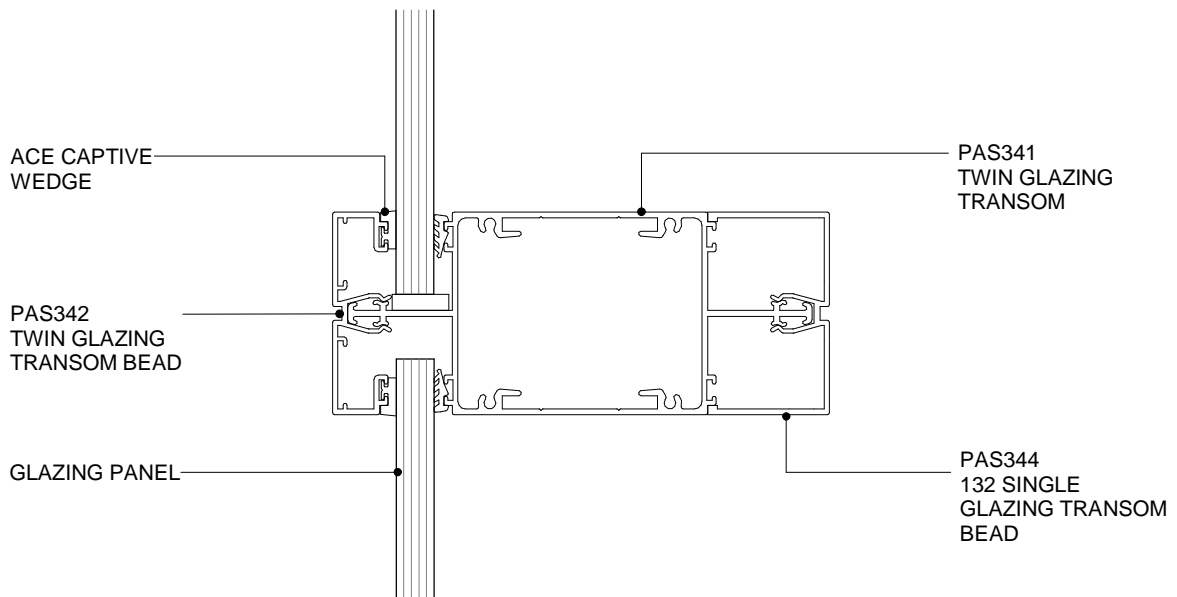
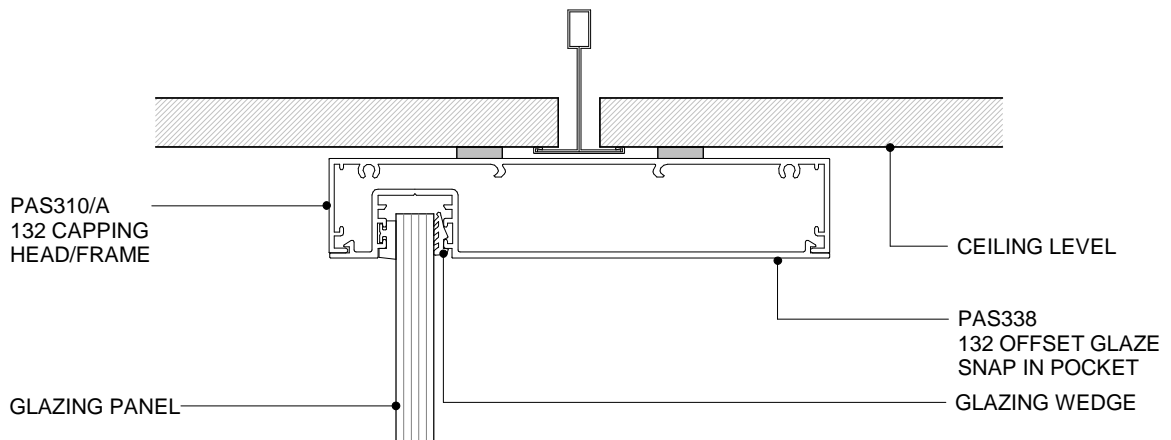

**POTTER ALUMINIUM SYSTEMS
E SERIES 132 - LARGE GLAZING**

CROSS SECTION

9.4.4
SHEET

1:2@A4
SCALE

A 01/04/2020
ISSUED DATE

0800 POTTER (0800 768 837) WWW.POTTERS.CO.NZ
SUBJECT TO CHANGE WITHOUT NOTICE



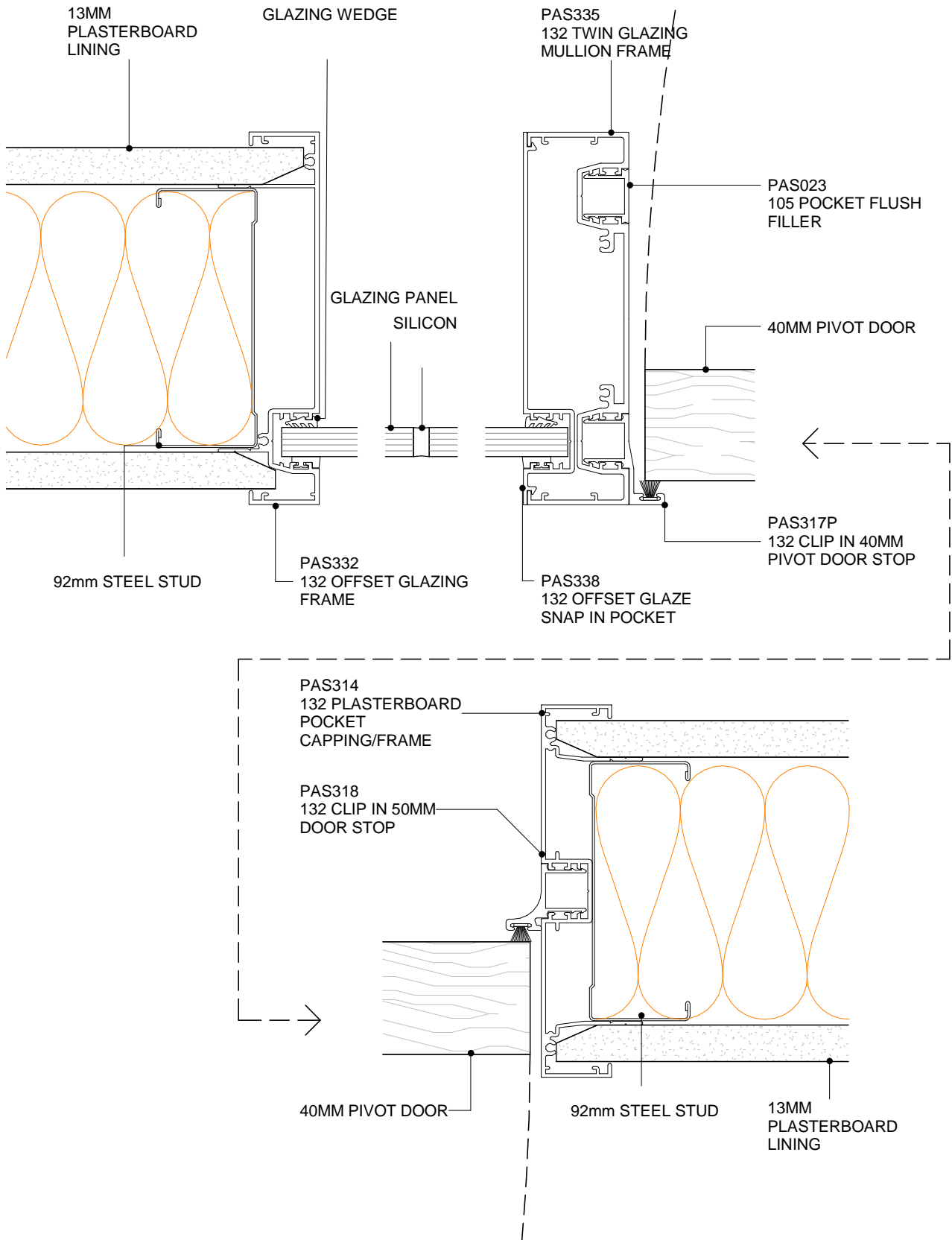

POTTER ALUMINIUM SYSTEMS
E SERIES 132 - 92MM - LARGE MULLION & PIVOT DOOR WALL
PLAN VIEW

9.4.5
SHEET

1:2@A4
SCALE

A 01/04/2020
ISSUED DATE

0800 POTTER (0800 768 837) WWW.POTTERS.CO.NZ
SUBJECT TO CHANGE WITHOUT NOTICE



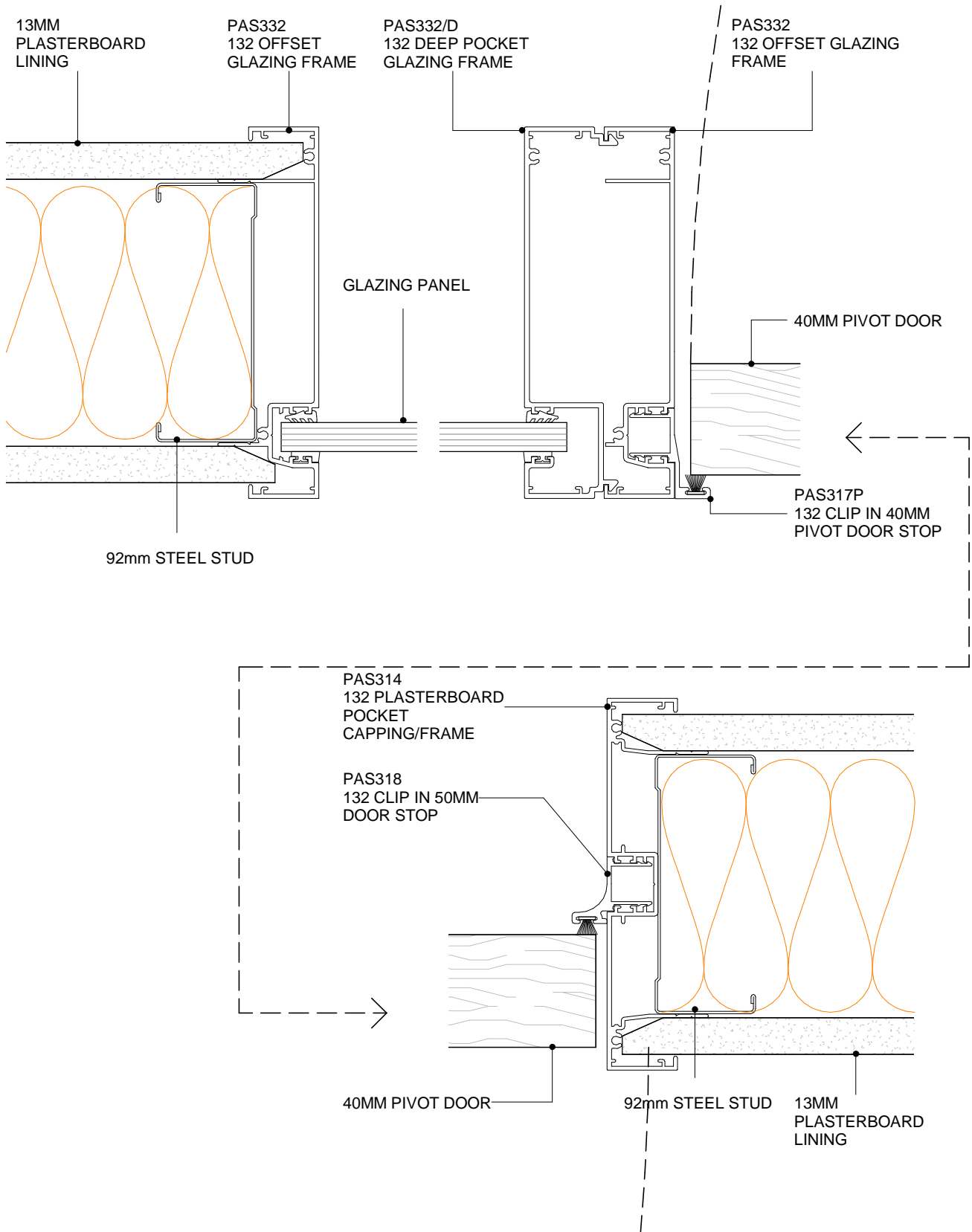

POTTER ALUMINIUM SYSTEMS
E SERIES 132 - 92MM - LARGE MULLION & PIVOT DOOR WALL
PLAN VIEW

9.4.6
SHEET

1:2@A4
SCALE

A 01/04/2020
ISSUED DATE

0800 POTTER (0800 768 837) WWW.POTTERS.CO.NZ
SUBJECT TO CHANGE WITHOUT NOTICE

CSR

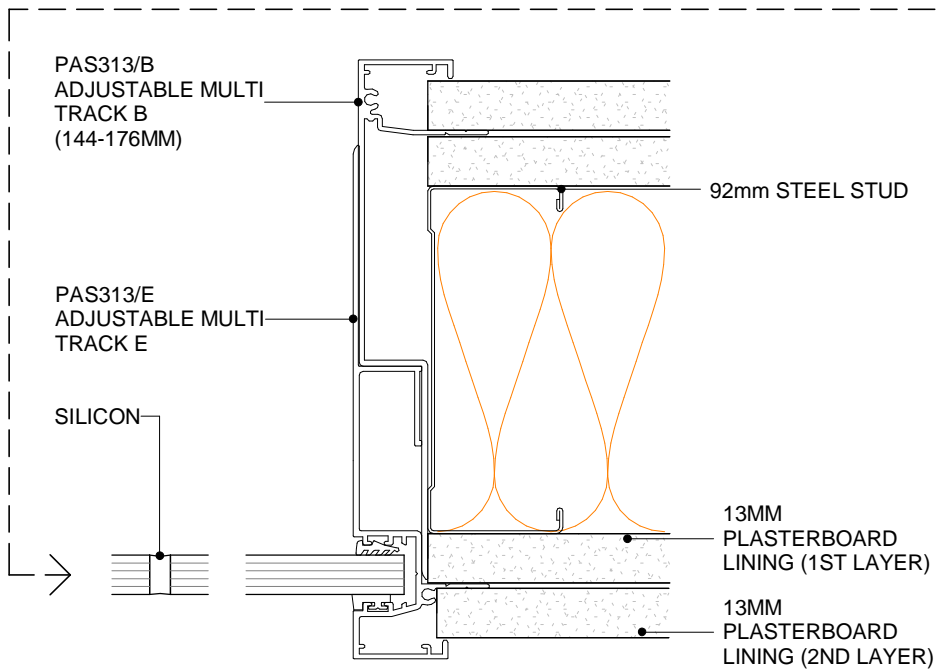
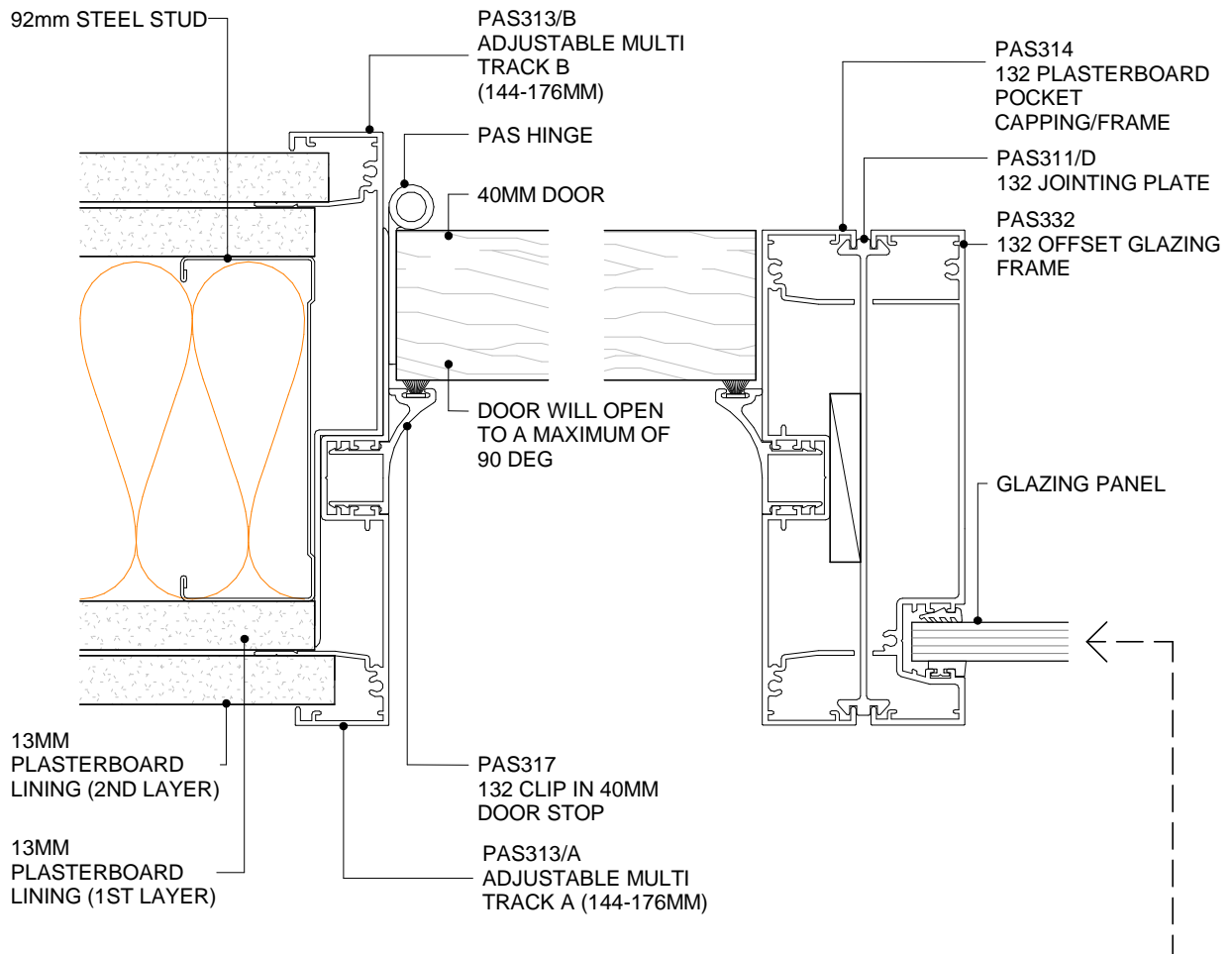

POTTER ALUMINIUM SYSTEMS
E SERIES 132 - 92MM - MULTI-LAYER DOOR DETAIL WITH OFFSET
SIDELIGHT (4 LAYERS)
PLAN VIEW

9.4.7
SHEET

1:2@A4
SCALE

A 01/04/2020
ISSUED DATE

0800 POTTER (0800 768 837) WWW.POTTERS.CO.NZ
SUBJECT TO CHANGE WITHOUT NOTICE



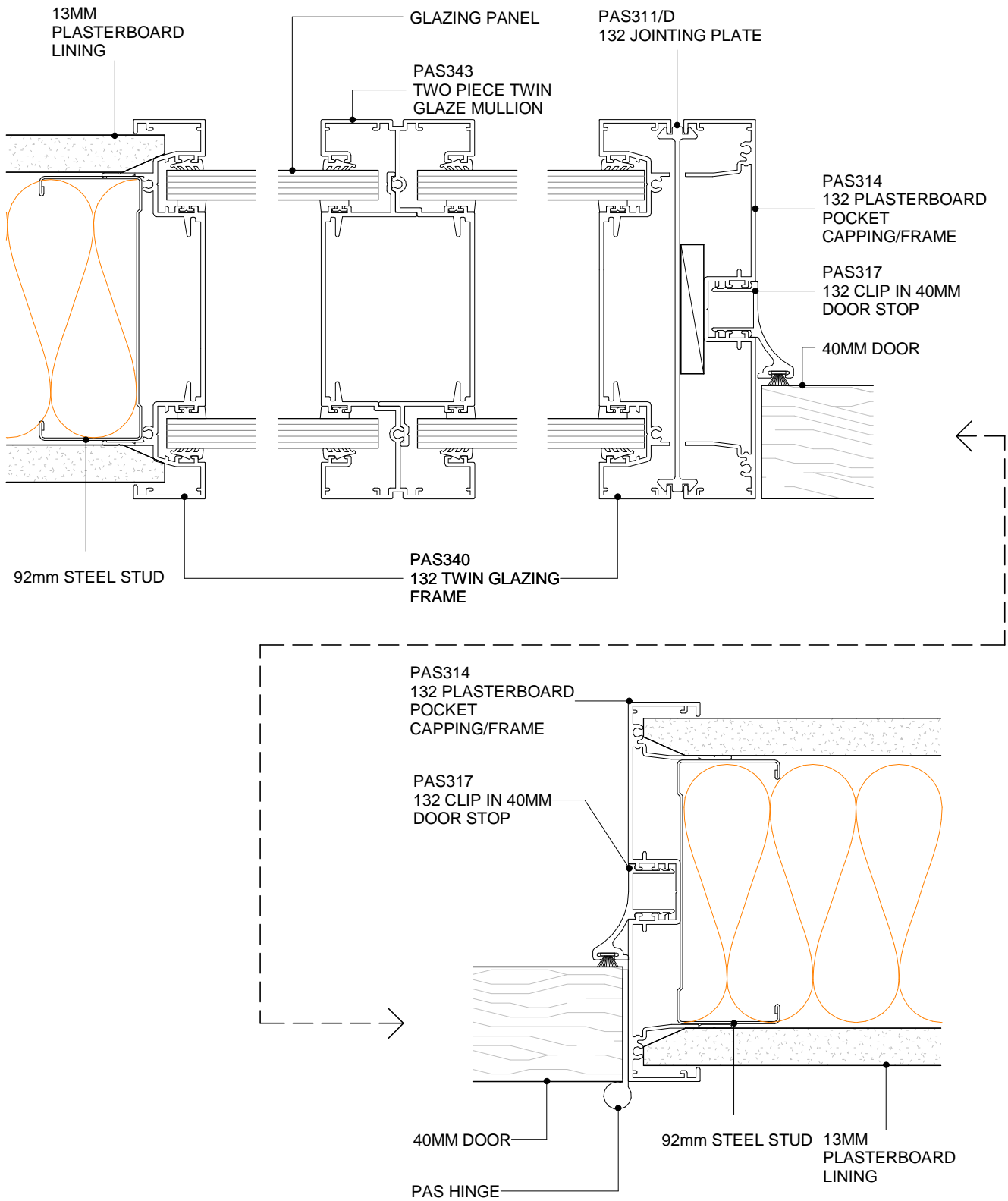

POTTER ALUMINIUM SYSTEMS
E SERIES 132 - 92MM - TWIN GLAZING MULLION & DOOR WALL SECTION
PLAN VIEW

9.4.8
SHEET

1:2@A4
SCALE

A 01/04/2020
ISSUED DATE

0800 POTTER (0800 768 837) WWW.POTTERS.CO.NZ
SUBJECT TO CHANGE WITHOUT NOTICE

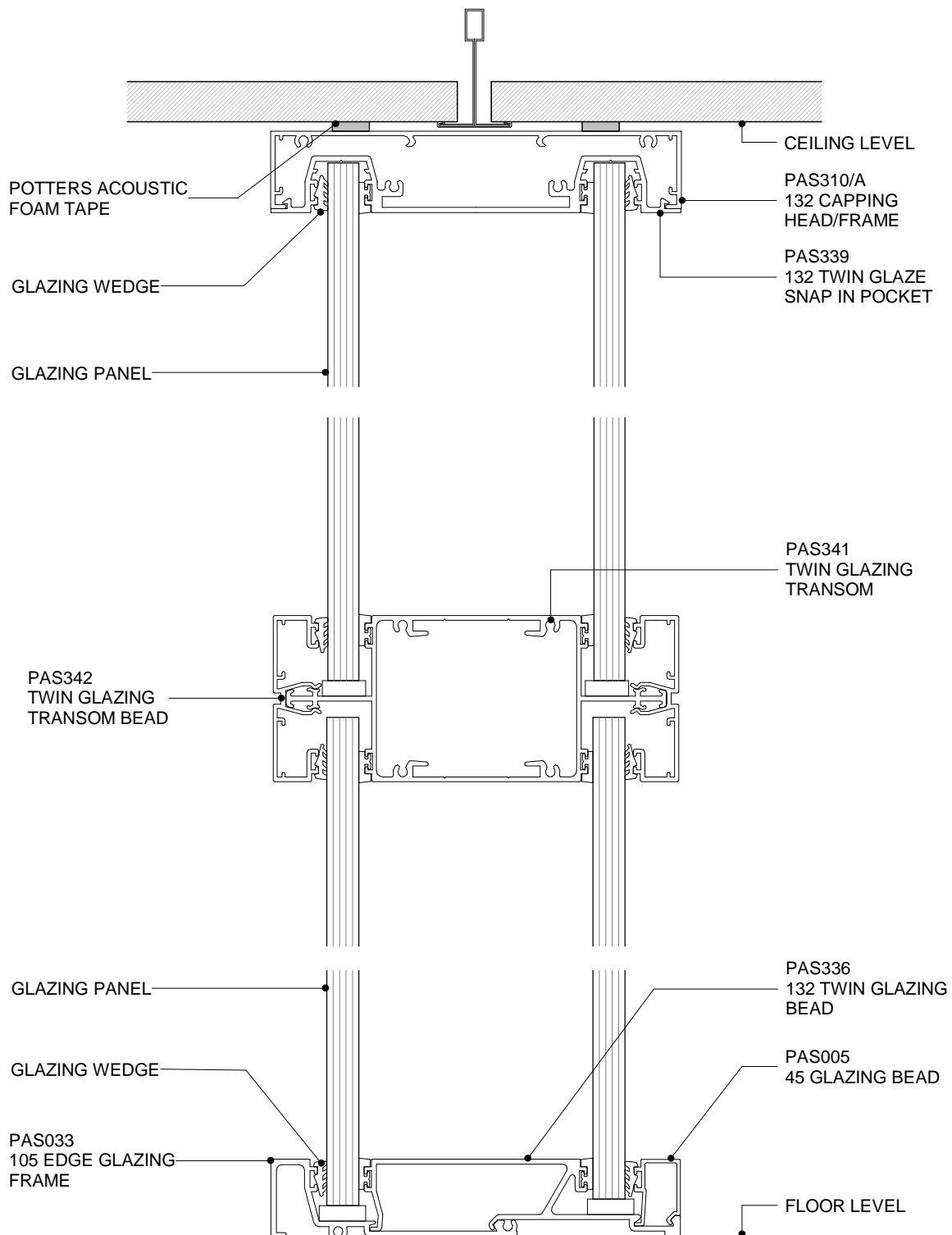

POTTER ALUMINIUM SYSTEMS
E SERIES 132 - TWIN GLAZING WALL TRANSOM
CROSS SECTION

9.4.9
SHEET

1:2@A4
SCALE

A 01/04/2020
ISSUED DATE

0800 POTTER (0800 768 837) WWW.POTTERS.CO.NZ
SUBJECT TO CHANGE WITHOUT NOTICE

