

# Powerline

## X2G Green Crossline Laser



### INSTRUCTION MANUAL

# SAFETY

Please read this instruction manual before operating this product.

Please store this instruction manual in the carry case for future reference.

## **CAUTION: Class 3 Laser Product**

Do not stare directly into the laser beam from apertures.

Do not disassemble the instrument or attempt to perform any internal servicing as this will void your warranty. No user serviceable parts included.

Only approved and authorised service technicians can carry out warranty repairs.

# ITEM CHECKLIST

Please ensure the following items are included with your laser.  
If anything is missing please contact your retailer.

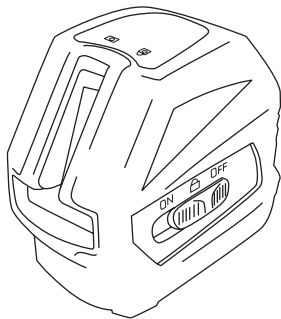

Powerline X2G



Laser target

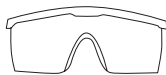

Laser glasses

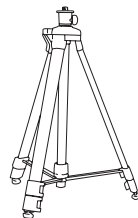

Indoor tripod



Levelling base

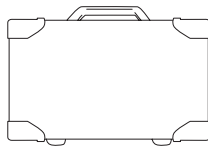

Carry case



Batteries

# PRODUCT OVERVIEW

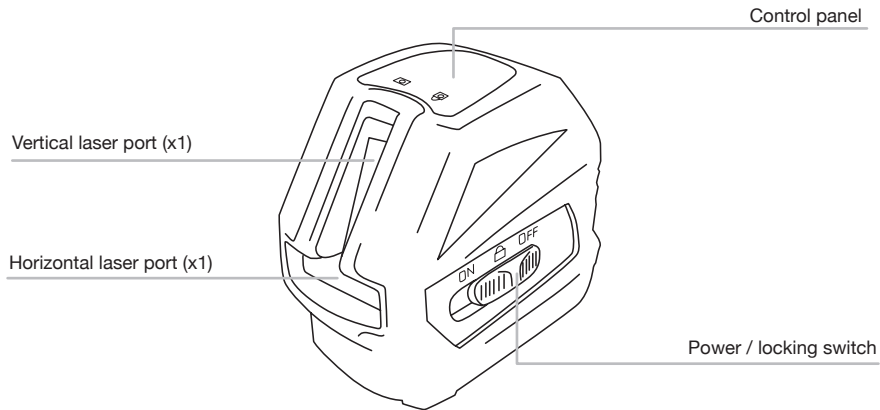

# CONTROL PANEL

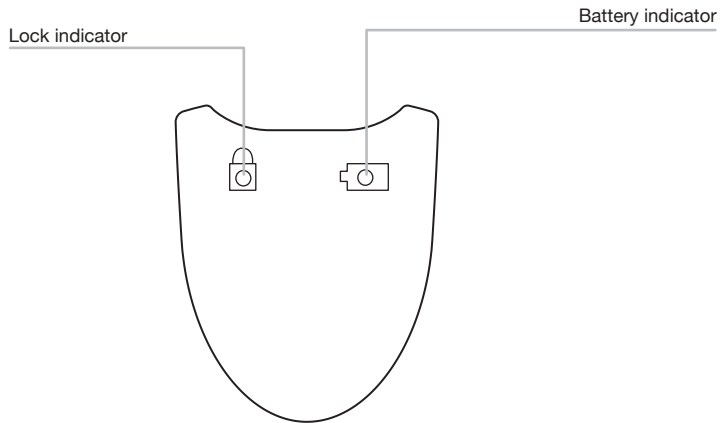

# USING YOUR LASER

## Power Supply

- ▶ The X2G is powered by three AA alkaline batteries.

## Setting Up

- ▶ Select a place as close as practical to the work site.  
Ensure the location is clear of traffic.
- ▶ Place the laser on a level surface such as a bench or mount.

## Operation

- ▶ To turn the unit on slide the *power* switch to “on” position.  
Self levelling will commence and the beams will appear.
- ▶ If the unit is outside the self levelling range the unit will not level causing the speaker to beep and the laser beam to flash repeatedly.

## Using the levelling base

- ▶ Unscrew the laser adapter from the centre of the levelling base.
- ▶ Screw the laser adapter into the base of the unit until firm.
- ▶ Insert the laser adapter into the levelling base and push forward to secure into place.
- ▶ For storage, follow the steps in reverse order.

**1**

laser adapter

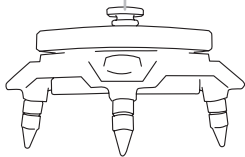

**2**

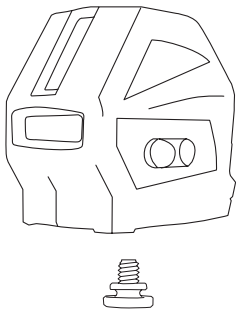

**3**

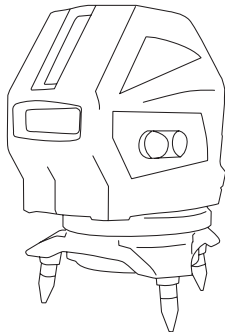

# CARE AND MAINTENANCE

- ▶ This is a precision instrument and should always be transported within the carry case provided.
- ▶ Always turn the on/off lock to “off” when transporting the unit.
- ▶ Whenever possible, store the instrument in a dry, shady location.
- ▶ The X2G should be calibrated every 6 months, if ongoing accurate levelling is required or an impact has occurred.
- ▶ The operator should check the X2G for accuracy before precision levelling is attempted.
- ▶ Clean the instrument with a dry, soft cloth after use in dusty, damp or wet conditions before storing.
- ▶ Smudges and fingerprints may be removed with a damp tissue or a soft, lint-free cloth.



# WARRANTY

## **The Powerline X2G comes with a 3 year manufacturers warranty.**

Our goods come with guarantees that cannot be excluded under the Australian Consumer Law. You are entitled to a replacement or refund for a major failure and for compensation for any other reasonably foreseeable loss or damage. You are also entitled to have the goods repaired or replaced if the goods fail to be of acceptable quality and the failure does not amount to a major failure.

Separate to the above Australia Consumer Law, *Spot-on* offers a global warranty.

## **30 Day Free Service**

If your laser is out of calibration within the first 30 days of purchase you are entitled to a free calibration adjustment. For more information please contact your retailer or *Spot-on*.

## **Customer Support**

To assist you with any queries or technical questions please contact the customer support line: 1300 658 338

# SPECIFICATIONS

<b>Specifications</b>	<b>Powerline X2G</b>
Product code	50061
Warranty	3 Years
Accuracy	±2mm at 10m
Range	50m (detector)
Levelling range	±4°
Laser class	3 Green
Battery life	10 hours
Battery type	3x AA
Vertical lines	1
Horizontal lines	1
IP rating	54
Weight (kg)	0.45
Dimensions (mm)	95x60x115



Available from



[www.potters.co.nz](http://www.potters.co.nz)  
0800 POTTERS | [info@potters.co.nz](mailto:info@potters.co.nz)  
Auckland, Wellington + Christchurch

