

CUSTOM WALL SOLUTIONS

WHITEBOARDS
PINBOARDS
NOTICEBOARDS
MOBILE BOARDS
DIVIDERS + DISPLAY



POTTER
INTERIOR SYSTEMS



ABOUT POTTERS

Established in 1966, we have a proud history of being the leading manufacturer of whiteboards to the commercial construction market throughout New Zealand. Supplying Kiwi classrooms, universities, retail and workplaces.

Offering a custom-made solution our range is favoured by designers looking for something unique. Proudly manufactured in our Auckland facility, using the highest quality porcelain, New Zealand extruded aluminium frames, solid substrates and locally made components.

Our range of innovative products include

- Whiteboards
- Pinboards
- Notice boards
- Mobile boards
- Glass boards
- Cabinet sliders
- Dividers + displays
- Acoustic solutions

CONTENTS

01	INTRODUCTION	
	Specification	4 - 5
	Benefits of Collaborative Spaces	6 - 7
	Sustainable Guarantee	8 - 9
	Whiteboard Care	10 - 11
	Our Aluminium Extrusions	12 - 13
02	EDGE LINE SERIES	14 - 19
03	FLATLINE SERIES	20 - 25
04	EDGE BAND SERIES	26 - 29
05	CABINET SLIDERS	30 - 33
6	MOBILE WHITEBOARDS	34 - 37
7	NOTICEBOARDS	38 - 40
8	FABRIC RANGE	41
9	MAGNETIC GLASSBOARDS	42 - 43
10	DIVIDERS, DISPLAYS	44 - 45
11	PORCELAIN + ACOUSTIC SOLUTIONS	46 - 47
12	LASER ETCHING	48
13	FAQ	49 - 50

Customisable Solutions

Potter Interior Systems have the capability and experience to successfully deliver custom-made solutions for the most demanding environments.

Providing a unique product range, we are the supplier of choice for whiteboard + pinboard solutions nationally.

We are proud to be the market leader with our products that meet the needs of the modern workplace. Potters products are designed to deliver the perfect solution for an innovative working and learning environment.

We stand by the products and solutions on offer through our commitment to customer satisfaction.

Design + Specification

We offer professional design and specification support to help you choose, specify and detail our custom wall solutions into your projects.

We are committed to providing quality products and solutions that are functional, fit for purpose and look great architecturally.

All our products are backed with strong technical support, warranty and maintenance information available at www.potters.co.nz

Specifications are also available online with Masterspec branded sections for download.

Reach out to our team at specsupport@potters.co.nz for help to achieve your required design.



**NEW ZEALAND
MADE**



**CUSTOMISABLE
SOLUTIONS**



**WRITEABLE SURFACE
GUARANTEE**



**QUALITY
MATERIALS**



Building business together since 1966.



Benefits of Collaborative Workspaces

With technology throughout work environments and modern classrooms, writing surfaces are, and will remain, one of the most important tools.

Cognitive mapping research has shown that the physical process of writing and diagramming helps people learn and recall information. Using a writing surface is both tactile and visual, so the act of writing and drawing engages the user physically and mentally, which boosts learning.

People are 20% more likely to remember something if it's displayed on a wall.

Making proper use of vertical space with a whiteboard surface can facilitate group work, increase engagement, foster innovation and make thinking visible.

Incorporating writing surfaces into meeting rooms or classrooms allows individuals to brainstorm, communicate and share ideas with others.

Burrow 1



Sustainable Surface Guarantee

At Potter Interior Systems we care about the impact our products have on the environment. Not only do they facilitate learning, teaching, and collaboration; we make sure our whiteboards are extremely durable with a useful life of over 25 years.

In an effort to minimize the waste and emissions that go along with the manufacturing process the premium quality porcelain used in all our products is Cradle to Cradle Bronze certified, which focuses on the reusability and recyclability of the materials along with water consumption and waste generation.

Our carbon-neutral aluminium extrusions are sustainably sourced within New Zealand with the mill finish product carrying the Declare label. Being certified Red List free, ensuring they contain no nasty chemicals.

Since 2013, Potter Interior Systems have been a member of New Zealand Green Building Council (NZGBC) and as members we help to develop sustainable building initiatives and actively encourage green building practices across New Zealand.





Looking After Your Whiteboard

Before the first use of your new Whiteboard

1. If present, remove the protective film.
2. Wipe board with a clean cloth moistened with a high-quality whiteboard cleaner or soapy water
3. Wipe surface dry with a clean cloth

We recommend the following steps when cleaning your whiteboard to remove residue and maintain the surface.

1. Any ink should be removed with a disposable cloth
2. Wipe surface with a clean cloth moistened with high-quality whiteboard cleaner.
3. Wipe surface dry with a clean dry cloth free of ink
4. Surfaces used moderately should be cleaned once a week
5. Surfaces used more intensely may require more frequent cleaning

If you suspect the surface of your board is damaged, please contact us for further information on cleaning your board with a cutting compound.

Vision Whiteboard Cleaner available through Potters

- Suitable for use on all whiteboards to remove built up residue
- Restores your boards white shine
- Ideal for use at home, in classrooms and conference rooms
- Completely bio-degradable formula with natural ingredients
- Contains broad spectrum disinfectant with a pleasant smell
- Contact us for pricing



**Complimentary
spray bottle**



**500ml
spray bottle**



**5 litre
bottle**



**Bulk 20 litre
container with tap**

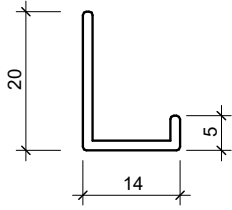

467371
9MM EDGE LINE

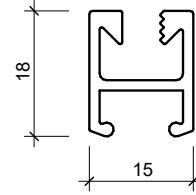

467355
4.75MM FLAT LINE

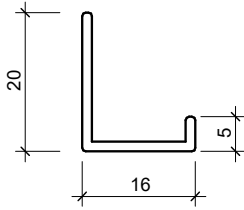

467372
12MM EDGE LINE

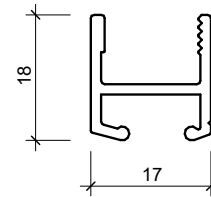

467375
12MM FLAT LINE

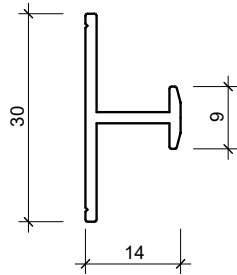

467380
9MM H JOINTER

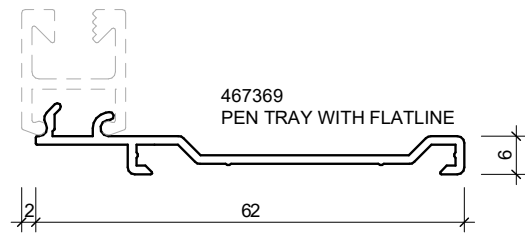

467369
PEN TRAY WITH FLATLINE

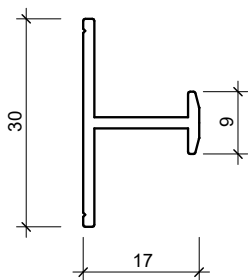

467382
12MM H JOINTER

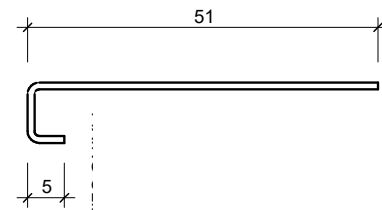

350539
FIXING CLIP

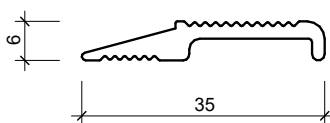

467084
SPLIT BATTEN

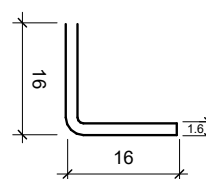

481120
FIXING ANGLE

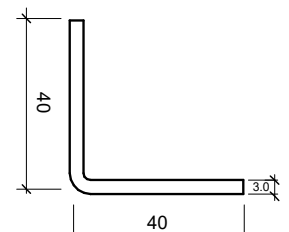

351596
FIXING ANGLE

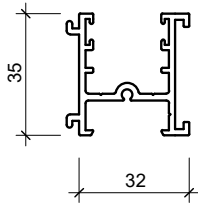

467361
CABINET SLIDER SINGLE TRACK

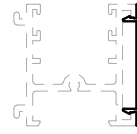

467368
CABINET SLIDER
FACE PLATE

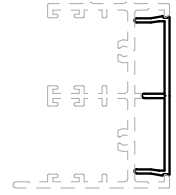

467358
COUNTERBALANCE
INFILL

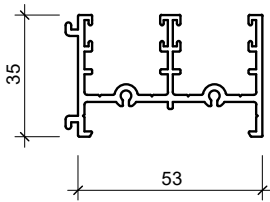

467364
CABINET SLIDER DOUBLE TRACK

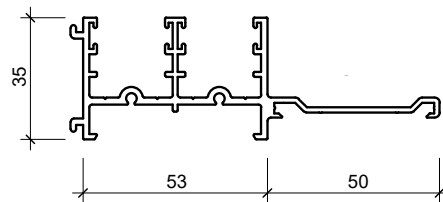

467366
CABINET SLIDER DOUBLE TRACK WITH PEN TRAY

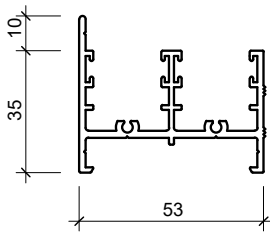

467357
COUNTERBALANCE FRAME

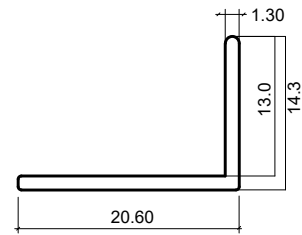

351595
12MM SLIMLINE BRACKET

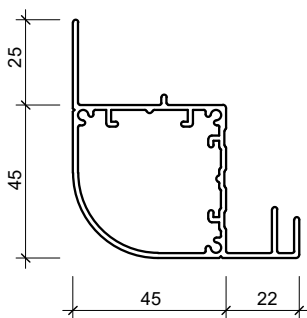

467384
LOCKABLE NOTICEBOARD FRAME

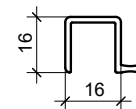

467360
CABINET SLIDER DOOR HANDLE FRAME

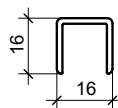

467377
CABINET SLIDER FRAME

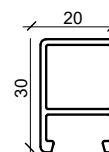

467374
DIVIDERS AND DISPLAYS

**PREMIUM QUALITY
WHITEBOARD SURFACE
WITH DESIGN FLEXIBILITY**

**Edgeline
Series**

- Whiteboard



Edgeline Whiteboard

Perfect for everyday use our premium quality porcelain on steel whiteboards provide the essential strength and longevity you need. The ultra-smooth surface is stain and scratch resistant and has low reflectivity.

Our Edgeline Series frame allows for flexibility of installation methods with two board thickness available. Our unique slim-line H jointer allows for almost seamless joints between two whiteboards giving it a continuous look that enables entire walls of whiteboards to be created.

Features

- Premium porcelain on steel writing surface
- Use with magnetic products + accessories
- Durable and resistant to scratches and stains
- Low reflectivity for use with a projector screen
- Solid aluminum backing
- Cradle to cradle certified porcelain - no VOCs
- 25 year surface guarantee
- Multiple install options

Finishing options

- Customisable height, width and design options
- Two thickness options available 9mm or 12mm
- Standard frames in black, white or anodised
- Frames can be powder coated to colour of your choice as an optional extra

Accessories

- Mechanical install components an optional extra

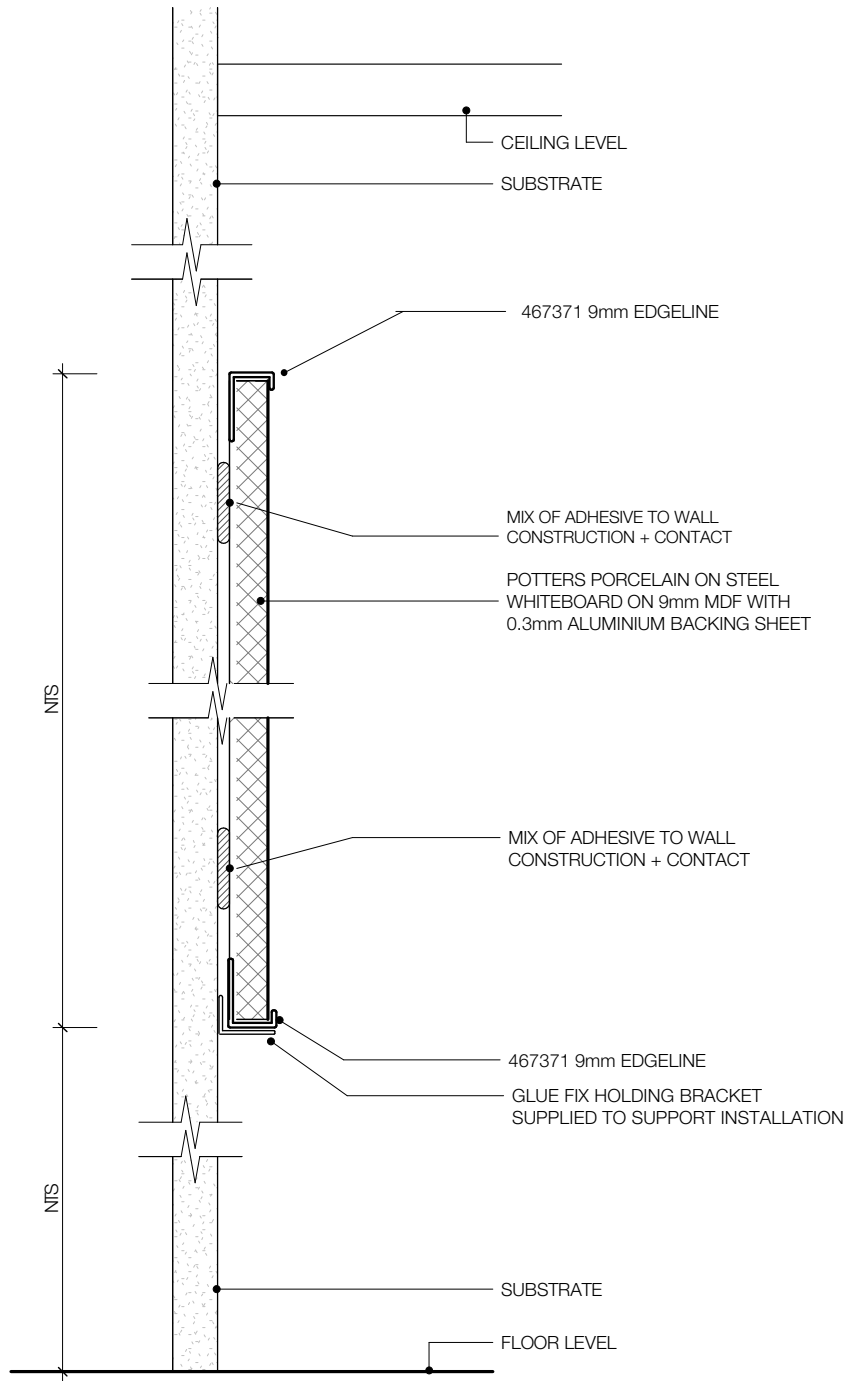

WHITEBOARD GLUE FIXED INSTALL - 9MM SUBSTRATE

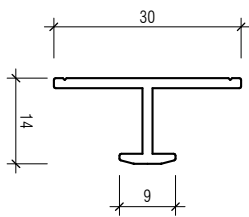

9MM H JOINTER
467380

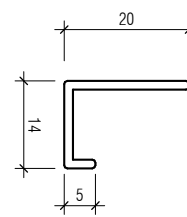

9MM EDGELINE
467371

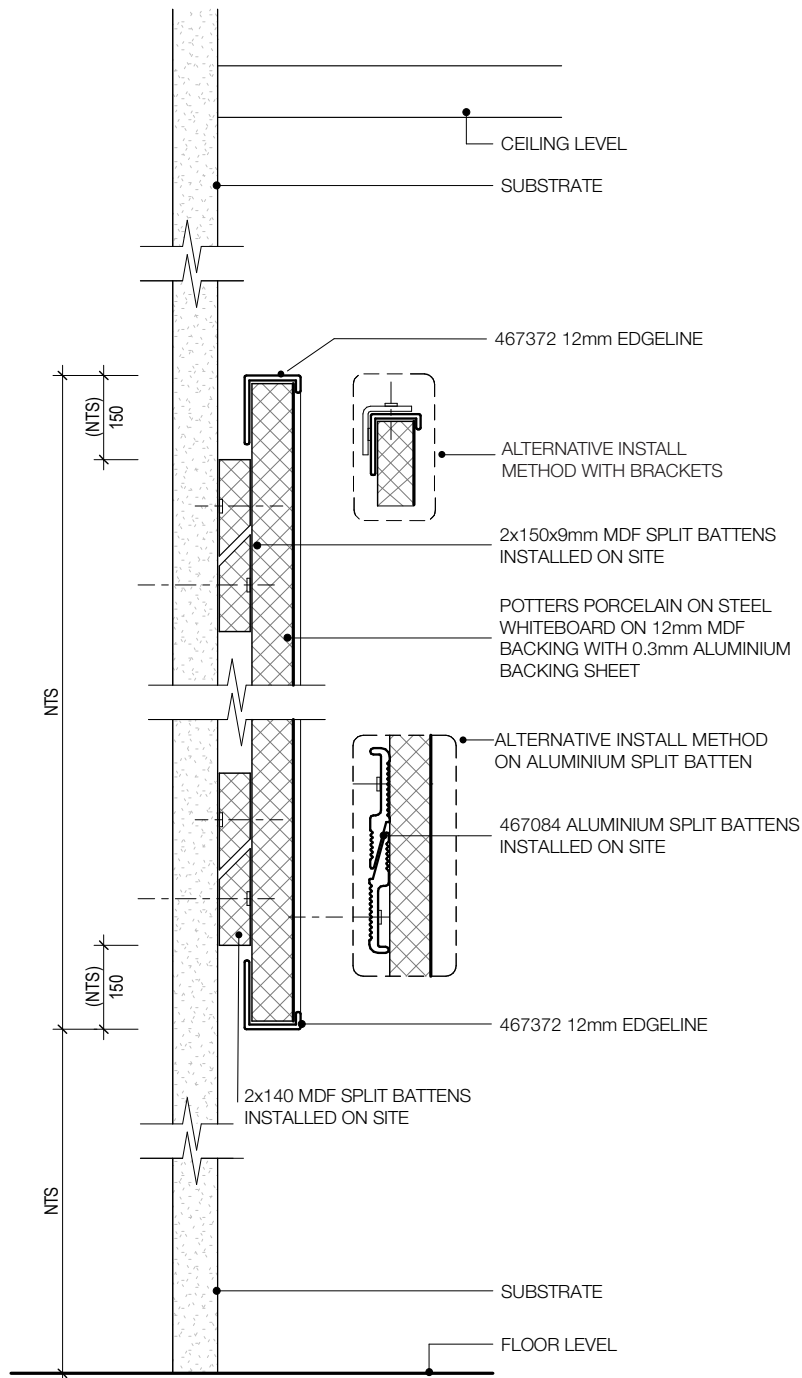

WHITEBOARD SPLIT BATTEN OR BRACKET INSTALL - 12MM SUBSTRATE

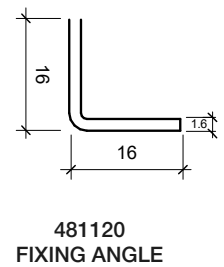
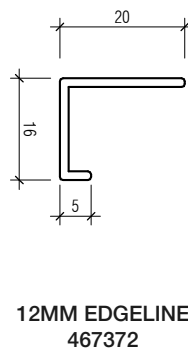
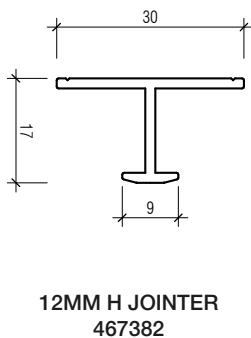
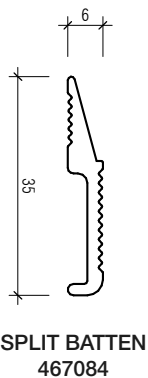



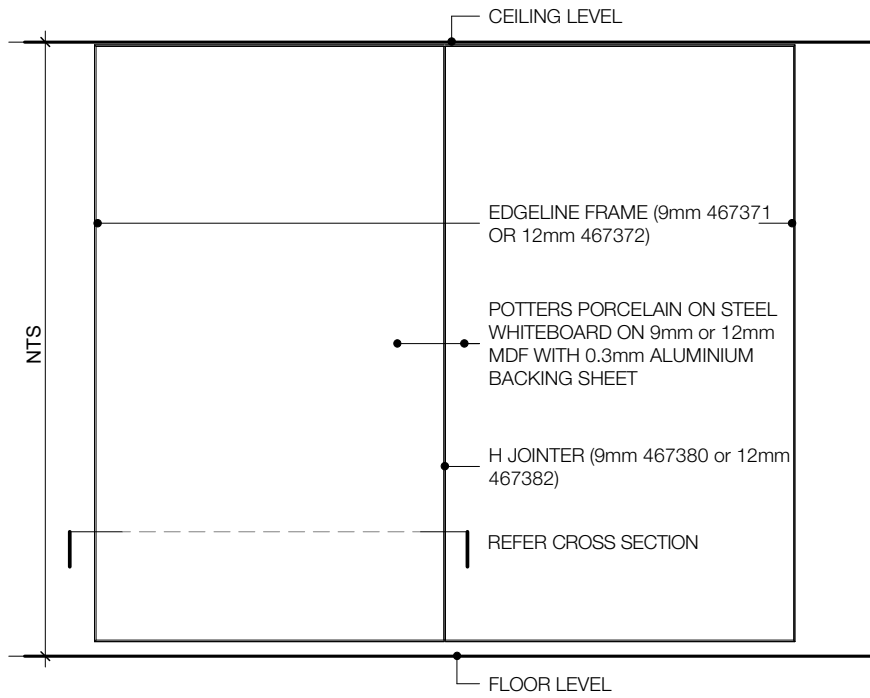

WHITEBOARD 9MM

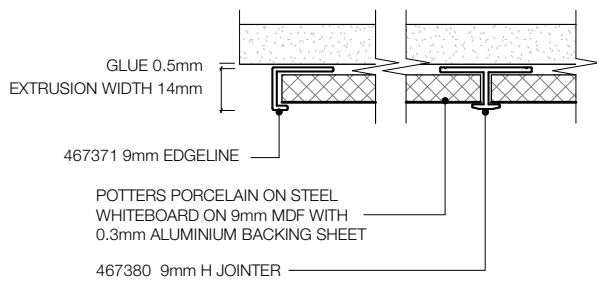

WHITEBOARD 12MM

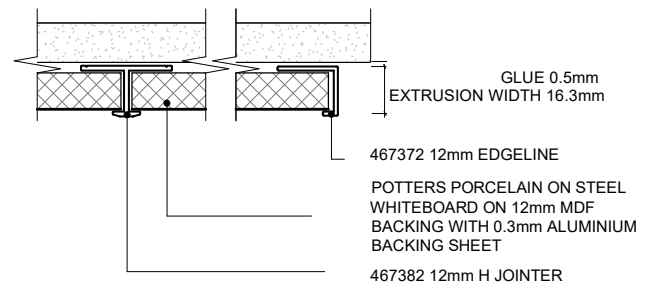

**EDGE LINE SERIES H JOINTER FOR JOINTED BOARDS
9MM OR 12MM MDF**

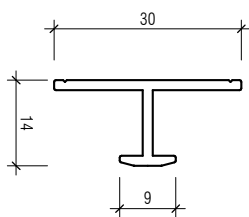

**9MM H JOINTER
467380**

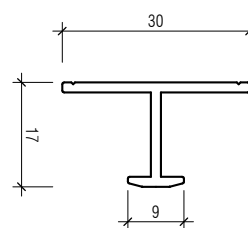

**12MM H JOINTER
467382**



Flatline Series

- Whiteboard
- Pinboard
- Combination
- Interactive



Flatline Whiteboard

Perfect for everyday use our premium quality porcelain on steel whiteboards provide the essential strength and longevity you need. The ultra-smooth surface is stain and scratch resistant and has low reflectivity.

Our Flat Line frame features clean lines and is low profile with moulded corners. This frame allows for easy installation and relocation of boards using our unique hidden fixing clips and installation method.

Features

- Stock held in standard sizes or made to order in customisable height and width options
- Premium porcelain on steel surface
- Use with magnetic products + accessories
- Durable and resistant to scratches and stains
- Low reflectivity for use with a projector screen
- Solid aluminium backing
- Cradle to cradle certified porcelain - no VOCs
- 25 year surface guarantee

Finishing Options

- Anodised aluminium frame
- Can be powder coated to colour of your choice as an optional extra
- Corner mitred option available

Accessories

- Aluminium pen shelf in anodised finish
- Hidden easy to install wall fixings supplied

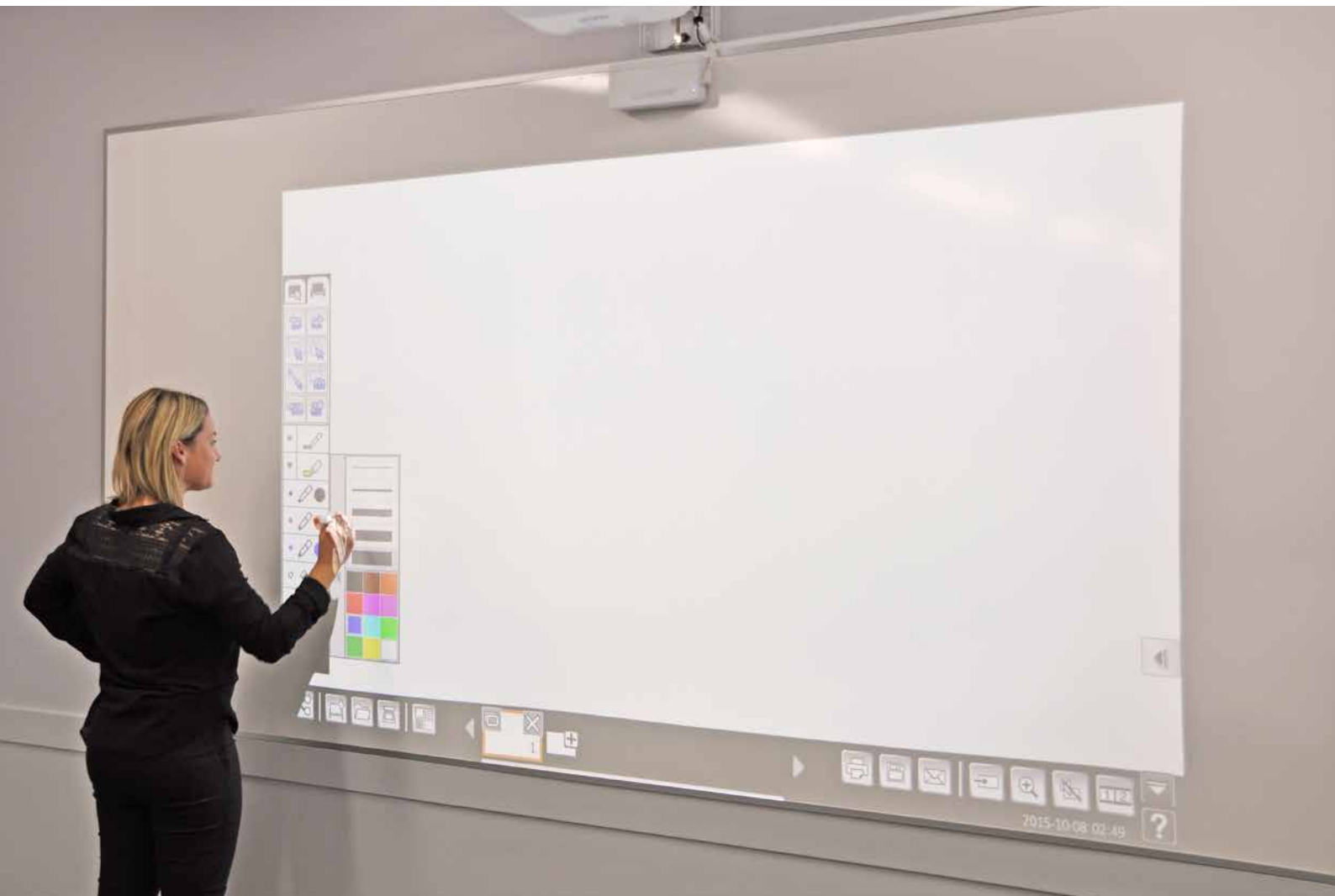

Interactive Whiteboard

Our premium interactive board is specifically designed for its superior image quality as a projection screen, whilst still allowing multi-purpose use as a marker board surface. This low reflectivity surface is perfect for image projection whilst still being an easy clean, scratch resistant surface.

Features

- 1500mm deep board to capture larger images
- Finger touch unit can be installed onto board
- Superior low reflectivity surface
- Magnetic receptive surface
- Durable, resistant to scratches and stains
- Strong aluminium frame with hidden fixings
- Cradle to cradle certified porcelain - no VOCs
- 25 year surface guarantee

Finishing Options

- Available up to 3.6 metres in length
- Two height options 1200mm or 1500mm
- Corner caps or mitred option

Accessories

- Hidden, easy to install wall fixings supplied
- Aluminium pen shelf in anodised finish

WALL HUNG BOARDS ON CLIPS WHITEBOARDS, PINBOARDS, COMBI AND INTERACTIVE BOARDS

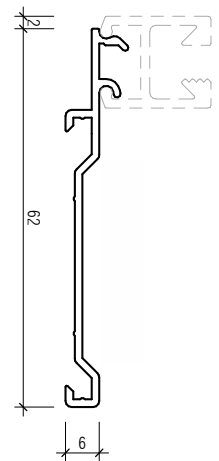
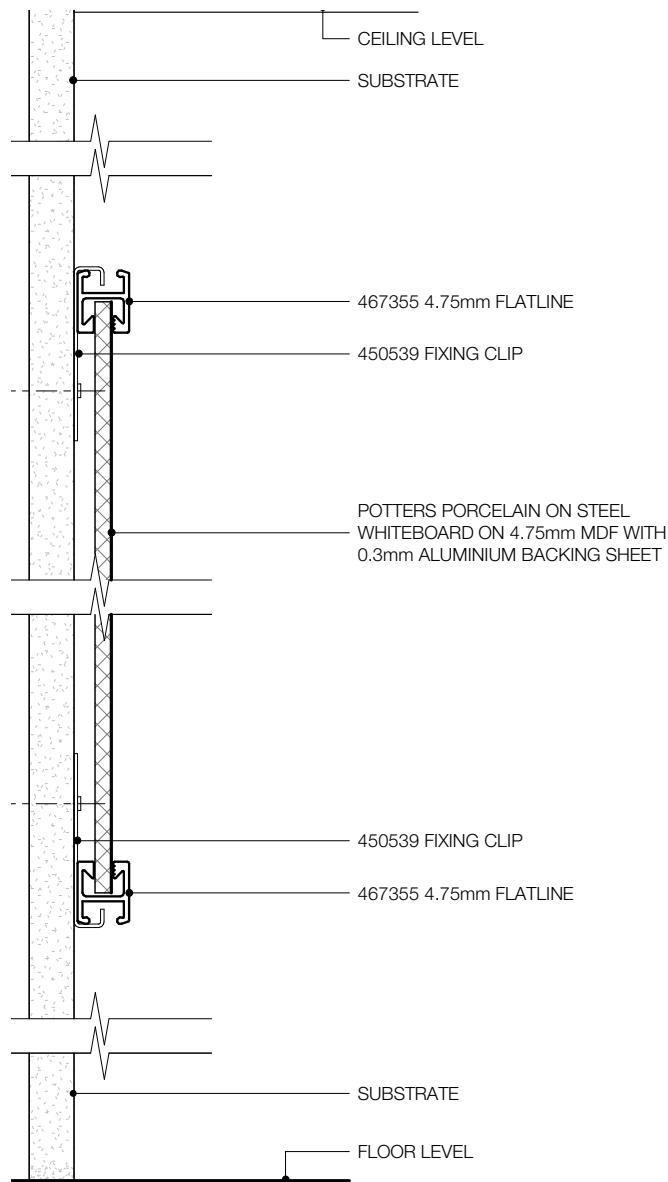

**PEN TRAY WITH FLATLINE
467369**

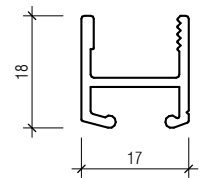

**4.75MM FLATLINE
467355**

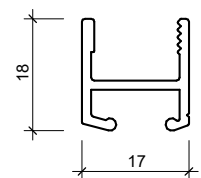

**467375
12MM FLATLINE**

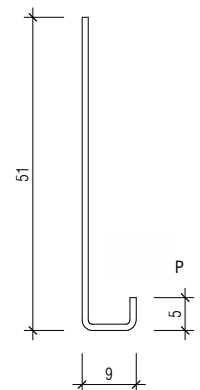
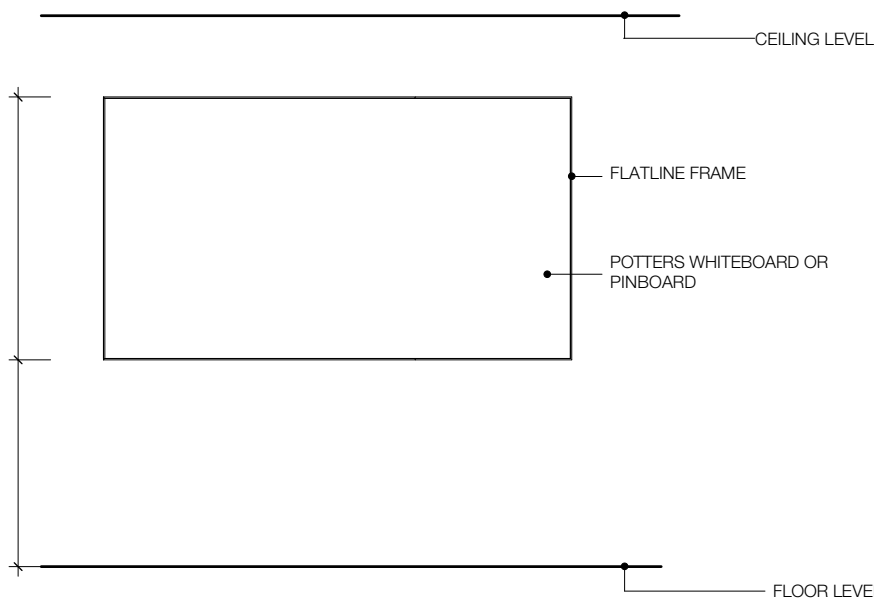

**FIXING CLIP
350539**

RECOMMENDED 900MM
OFF FLOOR LEVEL



Pin Board + Combination Board

Our functional and decorative pinboards are one of the easiest ways to display and communicate information. Customisable fabric colours to suit any indoor space such as school or office use.

Features

- Solid aluminium backing
- Highly durable and long lasting
- Long lasting pinnable surface
- Standard fabric range with over 30 colours to choose from

Finishing options

- Custom manufactured to suit your specifications
- Corner caps or mitred option
- Also available in a 4 edgewrapped finish
- Combination pin + whiteboard options available

Accessories

- Hidden, easy to install wall fixings supplied for Flatline frames only





Edgeband Series

- Whiteboard



Edgeband Whiteboard

Perfect for everyday use our premium quality porcelain on steel whiteboards provide the essential strength and longevity you need. The ultra-smooth surface is stain and scratch resistant and has low reflectivity.

The Edgeband Series is a frameless whiteboard with PVC edge banding offering a smart sleek look. It allows for flexibility of board thickness and installation methods.

Features

- Customisable height and width options
- Premium porcelain on steel surface
- Use with magnetic products + accessories
- Durable and resistant to scratches and stains
- Solid aluminum backing
- Cradle to cradle certified porcelain - no VOCs
- 25 year surface guarantee

Finishing options

- 1mm or 2mm PVC in various colour options
- Split batten installation for 12mm MDF and above



EDGEBANDED BOARDS - GLUE FIX INSTALL

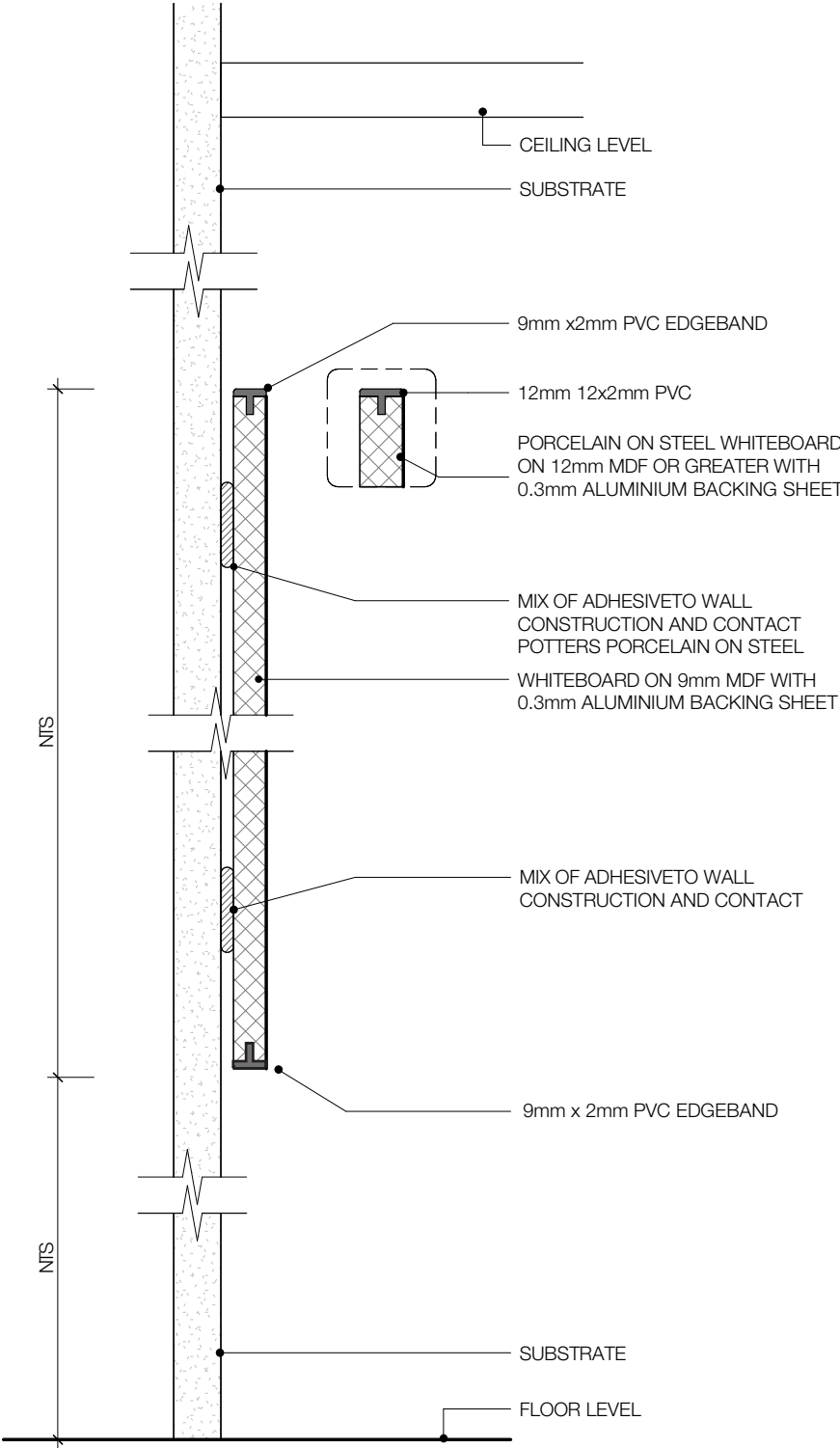



PREMIUM QUALITY
CABINET SLIDERS
PERFECT FOR **HARD-WORKING**
ENVIRONMENTS



Whiteboard Cabinet Slider

A whiteboard cabinet is an excellent way to optimise your storage space within a room. We supply the highest quality frames and sliders that have been favourites of teachers for many years. The system is secure, reliable and designed specifically for hard working environments. Our flexible system gives designers the ability to create unique designs.

Features

- Boards and frame made to suit the cabinetry
- Premium porcelain on steel surface
- Use with magnetic products + accessories
- Durable and resistant to scratches and stains
- Low reflectivity for use with a projector screen
- Solid aluminium backing
- Cradle to cradle certified porcelain - no VOCs
- 25 year surface guarantee

Finishing Options

- Doors can be installed with optional locks
- Track can be stacked due to our add-on design feature
- Layout can be customised as required



TOP + BOTTOM TRACK



FOUR SIDED TRACK

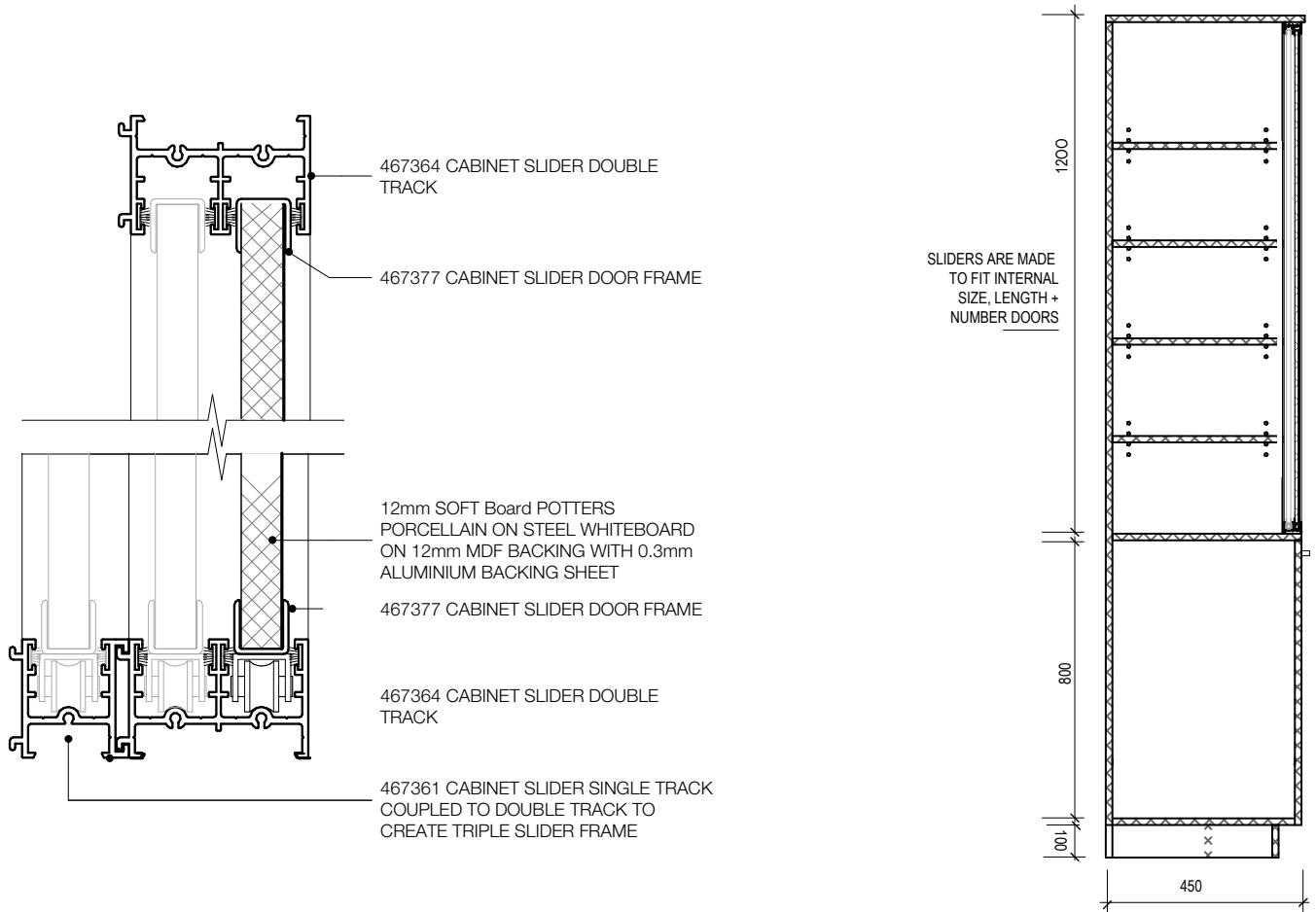

CABINET SLIDER FRAME OPTIONS

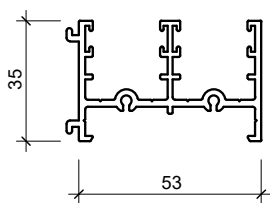

467364
CABINET SLIDER DOUBLE TRACK

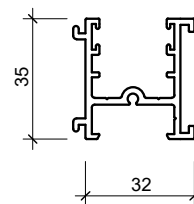

467361
CABINET SLIDER SINGLE TRACK

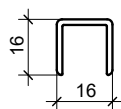

467377
CABINET SLIDER FRAME

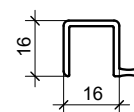

467360
CABINET SLIDER DOOR HANDLE FRAME

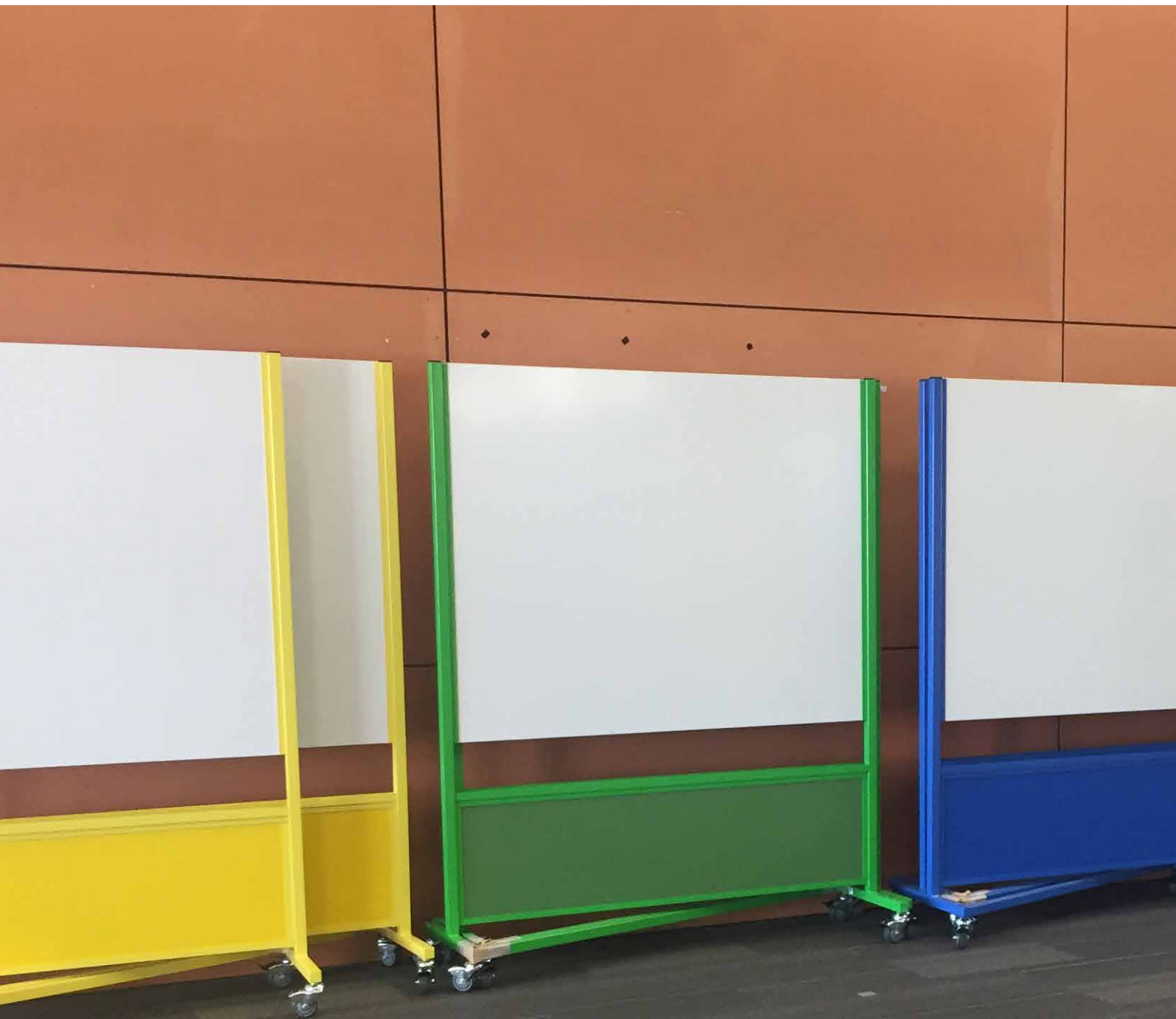

Mobile Whiteboards

- Thought Board
- Unity Board
- Focus Board

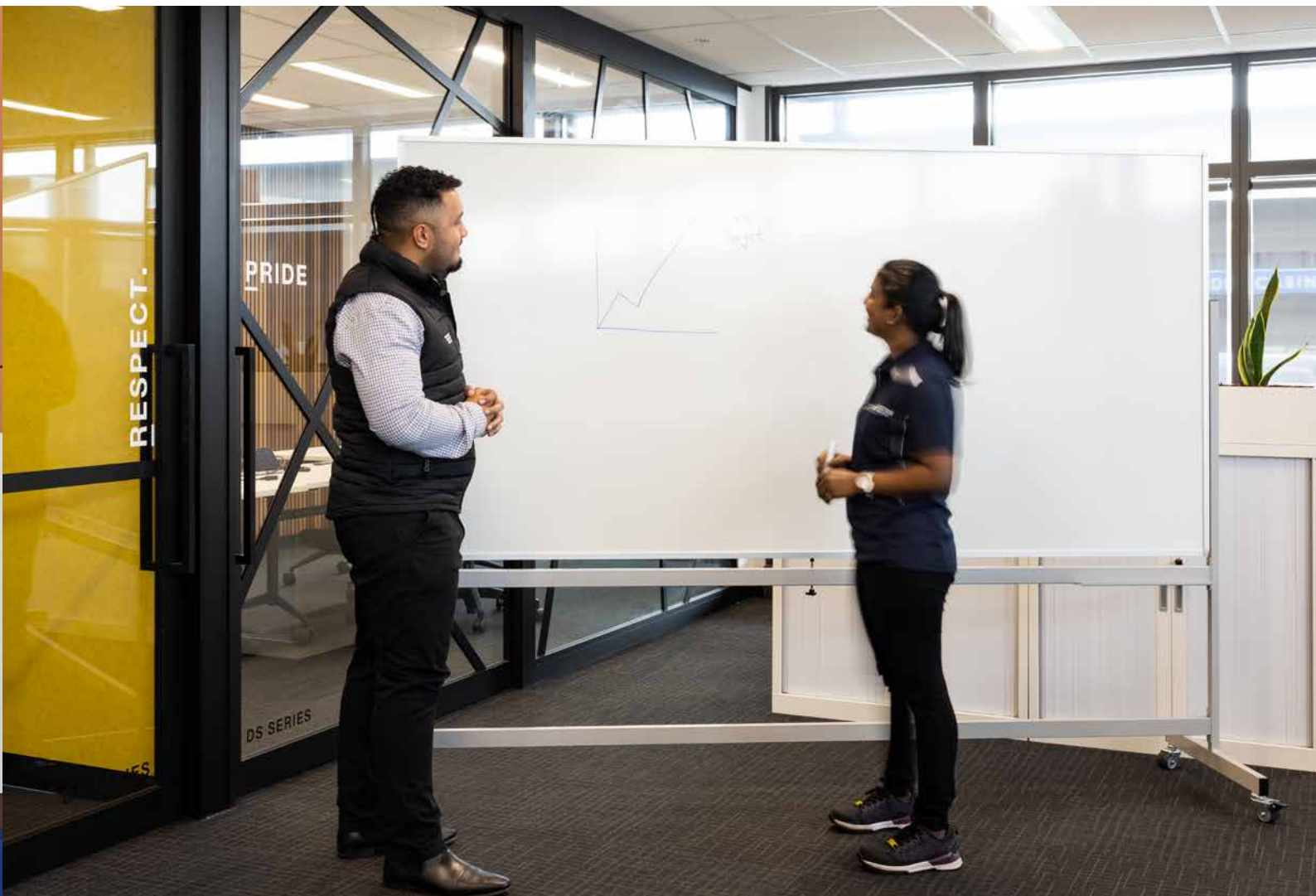

Thought Board Mobile Whiteboard

Manufactured in New Zealand our pivoting double-sided whiteboards are extremely robust being mounted on a high quality, powder coated steel frame.

The ultra-smooth enamel surface is stain and scratch resistant with low reflectivity.

Perfect for hard working environments, the robust castor wheels allow easy mobility between spaces.

Features

- Pivoting double-sided whiteboard on sturdy steel frame
- Premium porcelain on steel surface
- Use with magnetic products + accessories
- Easy glide wheels with locking mechanism
- Durable and resistant to scratches and stains
- Cradle to cradle certified porcelain - no VOCs
- 25 year surface guarantee

Finishing options

- Available in a range of standard sizes

Accessories

- Cleaning fluid supplied



Unity Mobile Whiteboard

Built to withstand tough environments, our Z shape base makes this one of the strongest frames available with a double sided porcelain-on-steel whiteboard.

Our robust Unity whiteboards are perfect for hard-working environments such as classrooms, training facilities and offices, where our customers have found this unit is a reliable long term investment.

Features

- Industrial size wheels with locking mechanism
- Low maintenance, welded frame steel frame
- The Z shaped base allows convenient stacking for multiple units
- Non pivoting whiteboard with additional pinboard surface included below
- Use with magnetic products + accessories
- Durable and resistant to scratches and stains
- 25 year surface guarantee

Finishing Options

- Available in a range of standard sizes
- Custom sizes and finishes available
- Choose from a selection of standard frame and fabric colours

- * 20x BURPEES
- * 10x MOUNTAIN CLIMBERS
- * 10x SITUPS
- * 15x CRUNCHES

CUSTOM MADE SOLUTIONS
FAVOURERD BY DESIGNERS



Lockable Noticeboard

- Noticeboards

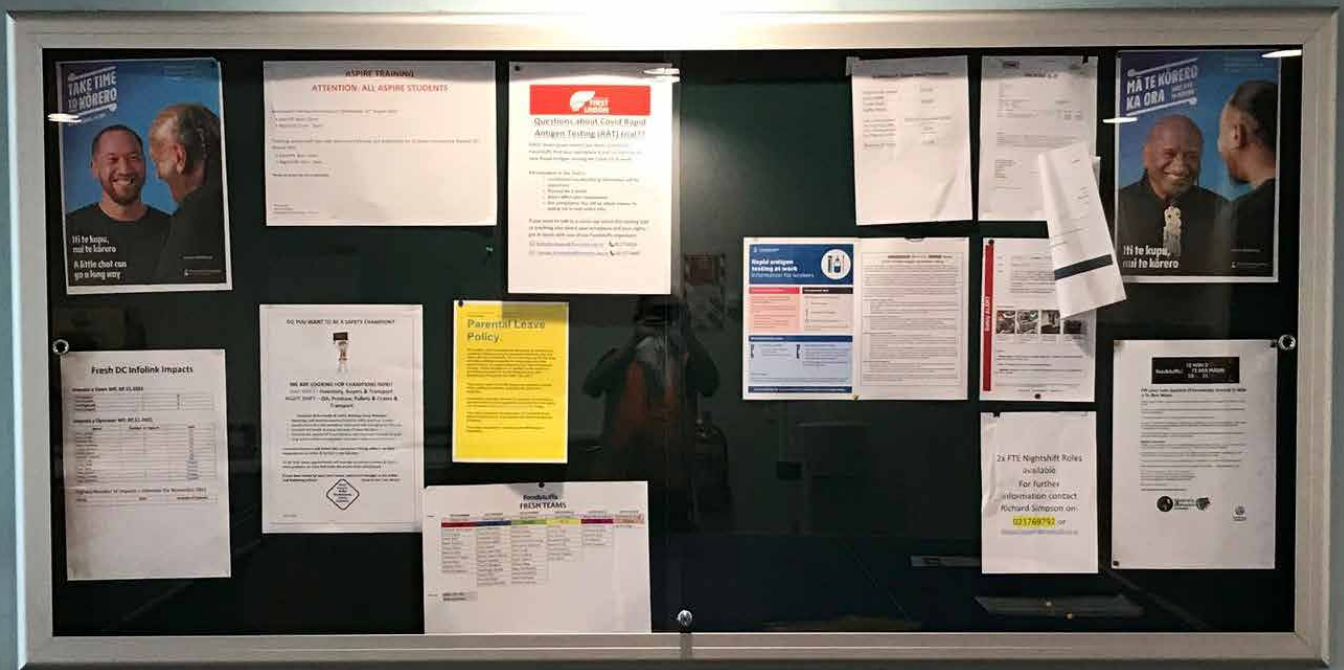

Lockable Noticeboard

Our Lockable Noticeboard Cabinet is brilliant for schools, community centres, staffrooms + more. The hard-wearing aluminium frame with glass doors makes it perfect for indoor and outdoor use. As one of the strongest in the market, these lockable noticeboards are an ideal way to securely display your important information.

Features

- High quality, robust aluminium framing
- Weather resistant for indoor or outdoor use
- Toughened glass sliding doors
- Tamper-proof barrell lock
- Highly durable and pin-able surface
- Standard fabric range with over 30 colours

Finishing options

- Made to order in custom and standard sizes
- Velcro or other fabrics available

Accessories

- Bracket wall fixings supplied

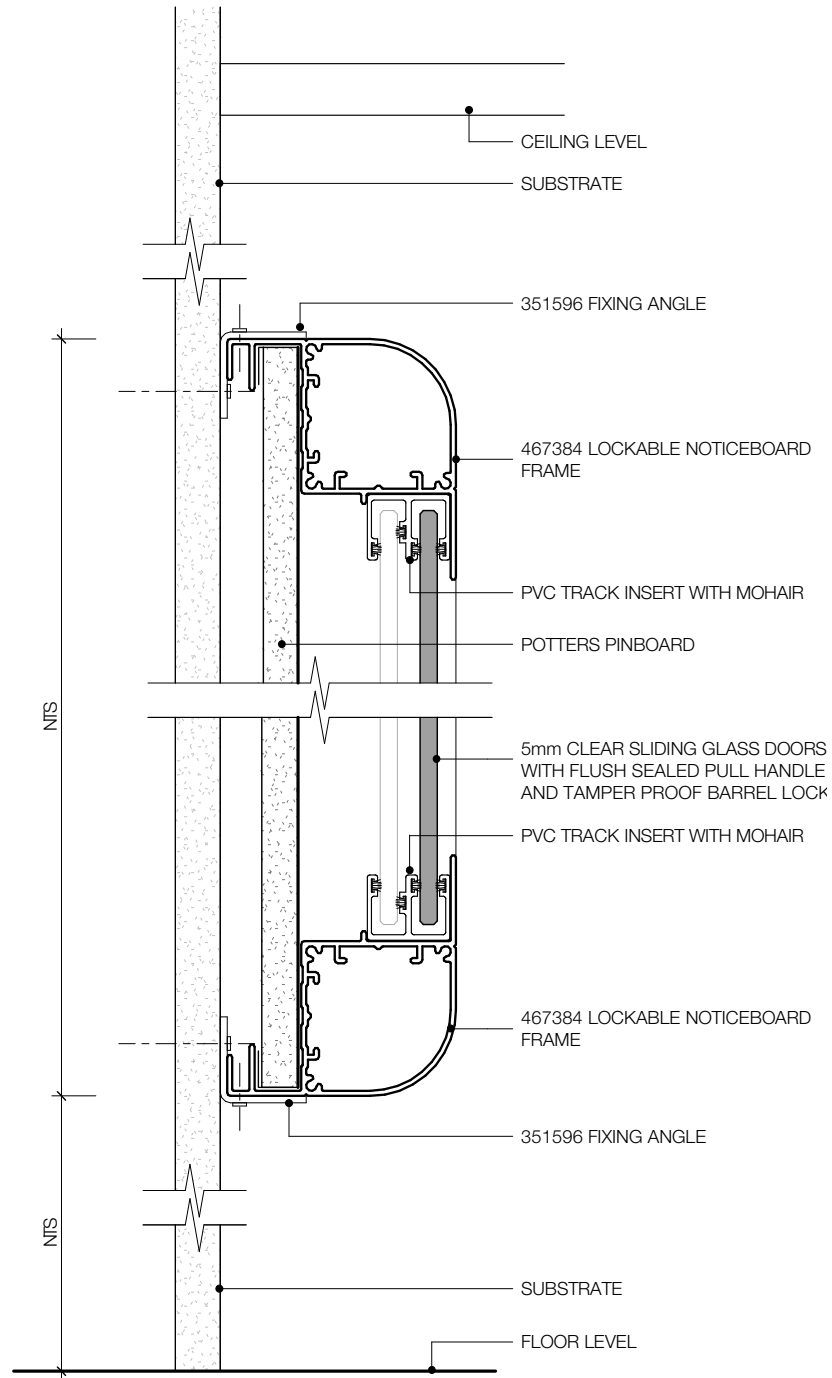

LOCKABLE NOTICE BOARD BRACKETED TO WALL

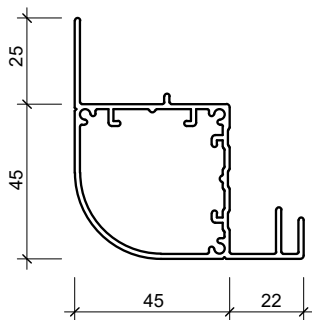

**467384
LOCKABLE NOTICEBOARD FRAME**

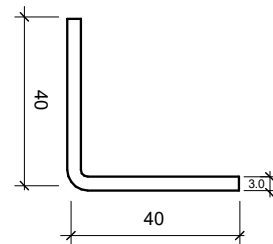

**351596
FIXING ANGLE**

Fabric Range

We offer two standard fabric ranges. The long lasting fabrics are extremely durable and suitable for use in commercial, hospitality, education and other hard-working environments.

Ranger



Quantum



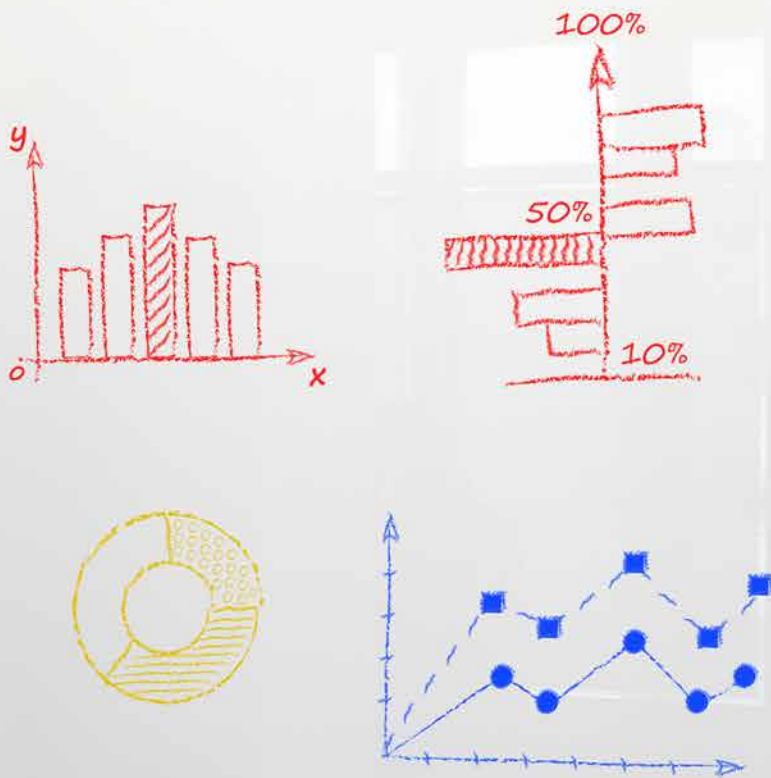

Additional Ranges

- Glassboards
- Divider + Displays
- Laser Etching
- Porcelain + Panels



Magnetic Glassboards

Perfect for any project requiring an elegant writing surface that is stain free and magnetic receptive. Our magnetic glassboards provide a sleek, timeless look and have been the choice for interior designers where presentation is important. Stylish fixtures float the board 20mm off the wall.

Features

- Toughened 4.5mm magnetic safety glass
- Conforms to: AS/NZS 2208:1996
- Clear low-iron glass allows a brilliant white finish
- Frame less tempered glass with polished edges and rounded corners
- White glass boards for use with standard dry erase whiteboard markers
- Black glass boards supplied with fluro markers
- Supplied with stand off fixings required to install

Finishing Options

- Available in a range of standard sizes
- Available in a black or white surface

Accessories

- Includes clear acrylic pen tray



Dividers + Displays + Focus Unit

Our premium pinboard or whiteboard dividers and displays are ideal as privacy screens or perfect for showroom displays and exhibitions. Customisable size and finishes using either our quality porcelain on steel whiteboard or pinboard surface. The versatile setup options allow for multiple uses of this incredibly simple system as a static or moveable unit.

Features

- Simple and robust frame constructed to ensure the longevity of this system
- Stable free standing panels or can be hinged together to create a sequence as required
- Our clever connecting foot allows the panels to be placed on any angle
- Interchangeable between feet and castor wheels
- Easy to install system with no tools required

Finishing Options

- Made to order in the size you require and finish of your choice
- These panels can be mounted onto castor wheels to be used as a Focus unit
- Available with either whiteboard or pinboard surface
- 25 year whiteboard surface guarantee





Porcelain + Acoustic Solutions

- Talk to us about adding these to any space



Porcelain Supply Only

Our premium quality, steel backed Porcelain is a great alternative to Laminates. Versatile in use it can be applied to many substrates such as MDF, Plywood, Polystyrene, ACM panels and more. This allows the porcelain surface to be used in many demanding environments.

Features

- Scratch and stain resistant
- Flexibility in size options
- Not restricted to sheet sizes waste
- Cradle to cradle certified porcelain - no VOCs



Acoustic Solutions

Through our collaboration with leading manufacturers in New Zealand, we are able to offer an extensive variety of acoustic products and solutions. Our work in the fitout market means we can work along side specifiers, contractors and the end user.

Features

- Extensive supplier network and product range
- Practical advice for tailored acoustic solutions
- Flexible options not restricted to stocked items
- Extensive knowledge in supplying and installing acoustic products

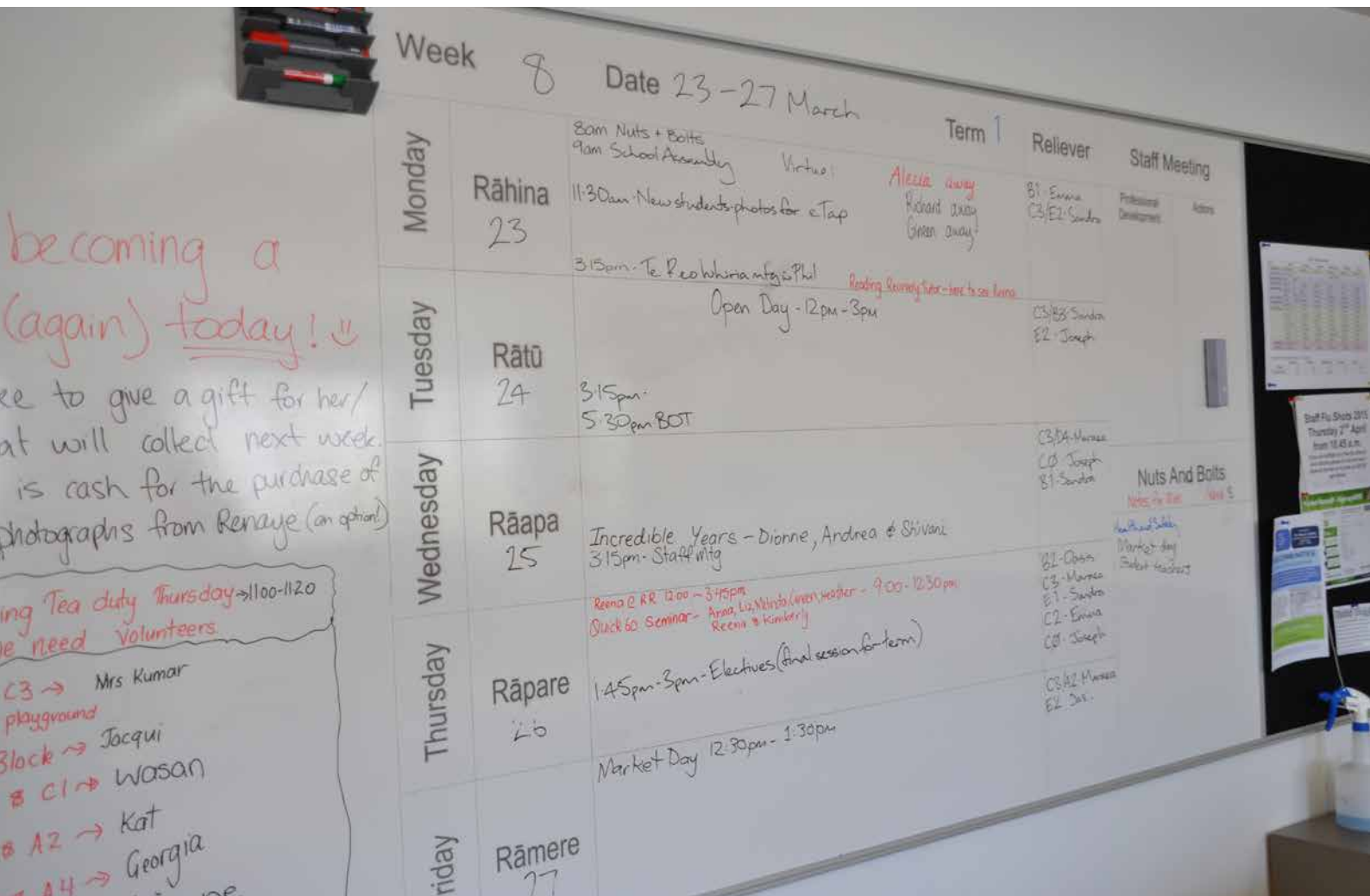

Laser Etching

Laser Etching is the process used to create permanent artwork such as grids, maps or pictures onto whiteboards. Our premium porcelain on steel surface is perfect for laser etching ensuring a high quality result. The Potters team can help realise your design ideas to create a personalised porcelain surface.

Features

- Permanently engrave artwork on the boards surface
- Clean lines that do not wear over time
- Premium porcelain on steel surface
- Use with magnetic products + accessories
- Durable and resistant to scratches and stains
- Solid aluminium backing
- 25 year surface guarantee
- Cradle to cradle certified porcelain - no VOCs

Frequently Asked Questions

Can I get help with installation?

In Auckland and other centres we can install the items detailed here as well as a range of acoustic wall linings. However we can not offer this installation service throughout New Zealand. Please contact us directly for a quotation.

How do I order a cabinetslider + track, and is everything included?

Firstly we need to quote this item as it is made to order. We need to know the estimated overall height and width, the number of doors and the style as per page 32. We then supply the complete track and sliding doors, ready to be installed into your cabinet.

How long will Potters take to supply my order?

If you select from our range of stocked items we can supply within days. If your item is made to order we would generally take 7-10 days plus freight. Larger orders are best placed as soon as possible.

Can I get Potters product throughout NZ?

Yes. Potters can arrange freight as required. You can get assistance from any of our four branches in Auckland, Hamilton, Wellington and Christchurch.

What is porcelain?

e3 CeramicSteel writing surface is manufactured as a continuous coil-coating process. Consisting of a steel core of light gauge covered on both sides with thin enamel coatings. The ceramic finish is fused to the steel at a temperature in the range of 700 900 oC.

Are there other framing options available other than those detailed.

Potters can source other extrusions from local suppliers if required. We will confirm your design specifications with you and supply a custom quote .

Can I resurface my whiteboard?

Unfortunately not, as the surface of your board is made from a pre manufactured sheet material we can not replicate the process of kiln firing porcelain.

What is the biggest board I can have?

We can manufacture large boards however the size will generally be restricted by other considerations : Clear access to manoeuvre into a room, what will fit in a stairwell or lift and what can be freighted, handled and installed safely. We can offer several options to achieve larger boards that are jointed, but still appear as one overall board.

Can I have floor to ceiling whiteboards?

Yes you can, however planning is important as not all floors, walls and ceilings are level. We have tricks to keep everything looking great.

Can I use any cleaner on my whiteboard?

No you can not as some chemicals will permanently damage the surface of your board. It is best to keep to a proprietary whiteboard cleaner or soapy water. View detailed instructions on Page 11.

Frequently Asked Questions

What can I do if my whiteboard has become difficult to clean?

Potters recommend checking your board is not permanently damaged. By using a fine cutting compound as detailed on Page 11 you can cut and clean the surface back to fresh or establish that permanent damage has occurred and therefore you need to replace the board.

Can I get different coloured whiteboards like black chalkboard?

Potters can supply white, grey or green porcelain surfaces. White is the all round standard surface, grey is lower reflectivity and green can be used as a chalkboard.

Is porcelain a good surface for writing on in comparison to others?

The porcelain that Potters uses on all its boards is of the highest quality. Scientifically developed as the optimum surface for both writing on and reading from. As well as being scratch and stain resistant, porcelain is an easy clean surface.

Why do Potters boards look good after many years in busy environments?

Potters products are manufactured with the strongest components in the frames, substrates and surfaces. This protects the products from dents, warping and lost corners etc. The quality can be clearly seen, when compared to other products on the market. Your whiteboard should last a lifetime.

Are Potters products made in New Zealand?

Yes as we source all our materials from within NZ except for the Porcelain. Porcelain coil is not manufactured in New Zealand and can be imported from where it is made in Europe, Asia or America. We have our own extrusions which are made in NZ and we source all our other substrates and components locally.

Will Potters organise powdercoating if required?

Yes, we offer a range of powder coating options. We can happily quote and arrange this for you.

What other products do you stock ?

We are experts in the distribution of quality products and proven solutions to the commercial construction market throughout New Zealand. Our services include aluminium partitions, suspended ceiling grid and panels, insulation, passive fire protection, whiteboards, pinboards and acoustic wall coverings.

What is the history and reputation of Potter Interior Systems?

We are part of the CSR family of companies, which is publicly listed and operates to high standards, delivering reputable products in the construction sectors of Australia and New Zealand. Additionally, other well-known CSR brands in New Zealand, such as Monier Roofing, Bradford Gold Insulation, and Hebel, which further reinforce the reputation of the parent company.

For more information visit www.potters.co.nz



0800 POTTERS
www.potters.co.nz

AUCKLAND + HEAD OFFICE

393 Church Street, Penrose
Phone 09 579 1338

HAMILTON

127A Maui Street, Pukete
Phone 07 846 0050

WELLINGTON

20 Hutt Road, Petone
Phone 04 568 8855

CHRISTCHURCH

90 Antigua Street, Addington
Phone 03 338 8763

Potter Interior Systems, a division of CSR Building Products Ltd, is a manufacturer of whiteboard products and we offer express warranties against faulty manufacture as outlined at potters.co.nz.

Wall | Ceiling | Insulation | Passive Fire | Whiteboards + Pinboards
