

Material Properties and Vibration Isolation

Technical information

by getzner
sylomer®

General information on Sylomer®

Sylomer® is a special PUR elastomer manufactured by Getzner, which features a cellular, compact form and is used in a wide range of applications in the construction and mechanical engineering industries. In most cases, Sylomer® is used as a compression-loaded elastic support element. The characteristics of the elastic support can be adjusted to the structure, construction method and load requirements by selecting the specific type of Sylomer®, the load-bearing area and the thickness.

Sylomer® materials are available as a continuous roll and are particularly well suited as flat, elastic layers. Above and beyond this, engineered moulder parts made of Sylomer® are also available.

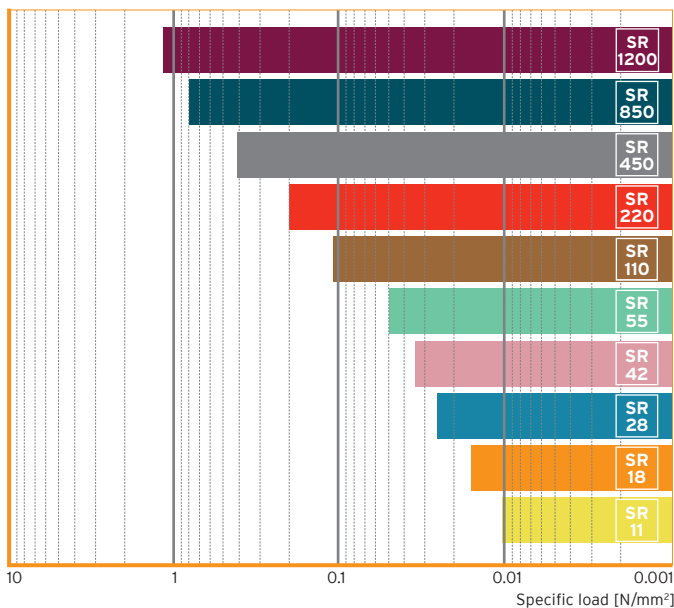

Diagram 1: Sylomer® product series

For specific applications, special types can be manufactured with precisely defined stiffness. The material's fine cellular structure provides the necessary deformation volume under static and dynamic loads. As a result, elastic bearings with full-surface load transmission are possible. This offers major engineering and economic advantages, especially in the construction industry.

Quasi-static load deflection curve

Diagram 2 shows the typical pattern of the load deflection curve for Sylomer® under compression load.

In the lower load ranges, there is a linear relationship between tension and deformation. For elastic bearings, the permanent static load should fall in this range. The load range is specified in the individual product data sheets.

After the linear load range, the load deflection curve moves on a degressive path; the material reacts to additional static and dynamic loads in a particularly "soft" manner, thus allowing for highly effective vibration isolation. In the product data sheets, the area of the deflection curve in which a high degree of efficiency is achieved with a relatively small degree of spring deflection, marked with the lighter shading in the diagram.

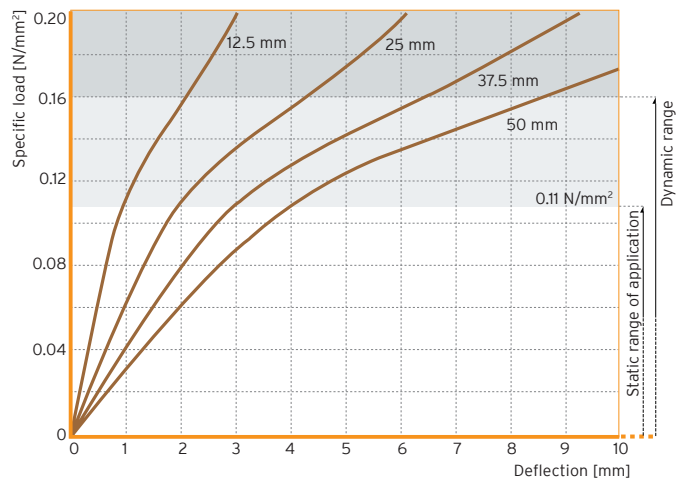

Diagram 2: Load deflection curve, using the example of Sylomer® SR 110

For loads and deformations exceeding the degressive range, the deflection curve is progressive (the darker shaded area). The material becomes stiffer. As a result, reduced vibration isolation efficiency can be expected in this load range. Sylomer® is not affected by overloading. After load removal, the material recovers almost completely even after very significant deformations resulting from brief, extreme load peaks. No damage is caused to the material. The compression set as per EN ISO 1856 for Sylomer® is less than 5 %.

Behavior under dynamic load

Diagram 3 shows the load dependence of the static and dynamic modulus of elasticity (at 10 Hz and 30 Hz). Just like all elastomers, Sylomer® reacts to dynamic loads more stiffly than to static loads. The stiffening factor depends on the Sylomer® type, the load and the frequency, and ranges between 1.4 and 4. In keeping with the path of the deflection curve, the quasi-static and the dynamic moduli of elasticity exhibit minimum levels. Sylomer® features particularly good vibration isolation properties in this load range. Accordingly, by using Sylomer® it has been possible to realize vibratory systems, which result in a high degree of isolation despite relatively small amounts of static subsidence.

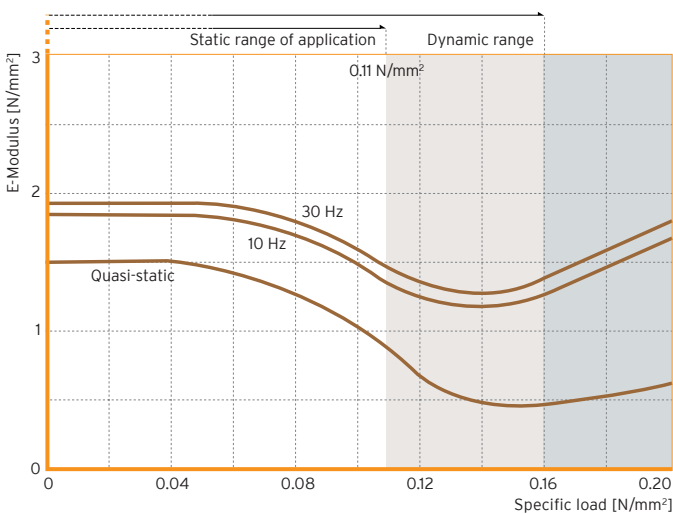

Diagram 3: Load dependence of the quasi-static and dynamic e-modulus, using the example of Sylomer® SR 110

Loss factor

When Sylomer® materials are subjected to dynamic loads, some of the mechanical work applied is transformed into heat by dampening effects. The dampening behavior of Sylomer® materials can be described by the mechanical loss factor, which ranges between 0.09 and 0.25 for Sylomer® materials. The specific values are shown on the product data sheets.

Behavior with shearing loads

Fundamentally speaking, a Sylomer® bearing is softer with regard to shearing loads than with regard to compression loads. The relationship of compression to shearing stiffness ranges between factor 4 and 10, depending on the cellular structure and geometry of the Sylomer® bearing. The quasi-static shearing deflection curve exhibits its relatively linear deformation behavior.

Impact of the form factor

Low density, cellular Sylomer® materials are volume-compressible. This means that, compared to more compact elastomers, elastic Sylomer® elements do not expand very much transverse to the direction of the load. On the other hand, Sylomer® bearings with a low form factor q (defined as the ratio of the load-bearing surface to the peripheral surface of the bearing, see Diagram 5) exhibit greater subsidence than can be derived from the deflection curves on the product data sheets (pages 2 and 3 show the deflection curves for form factor 3).

Page 4 of the product data sheets shows the dependence of the subsidence, the dynamic e-modulus and the natural frequencies on the form factor. These dependencies can be used as correction factors for the deflection curves on pages 2 and 3 of the product data sheets for different form factors.

Definition:
$$\text{Form factor} = \frac{\text{Load area}}{\text{Perimeter surface area}}$$

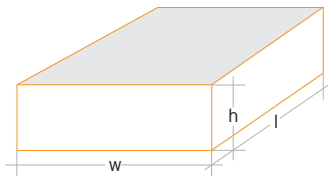

Block

$$q = \frac{w \cdot l}{2 \cdot h \cdot (w + l)}$$

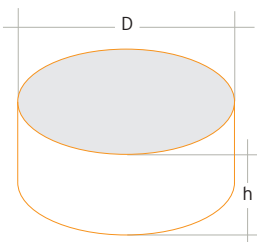

Cylinder

$$q = \frac{D}{4 \cdot h}$$

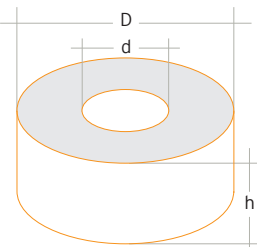

Hollow Cylinder

$$q = \frac{D - d}{4 \cdot h}$$

Diagram 5: Definition of the form factor, block, cylinder, hollow cylinder

Static long-term durability

As is the case with all elastomers, certain creep effects occur under long-term load. Creep refers to a reversible increase in deformation under unchanging, long-term load conditions. Diagram 6 shows the behavior typical for Sylomer®:

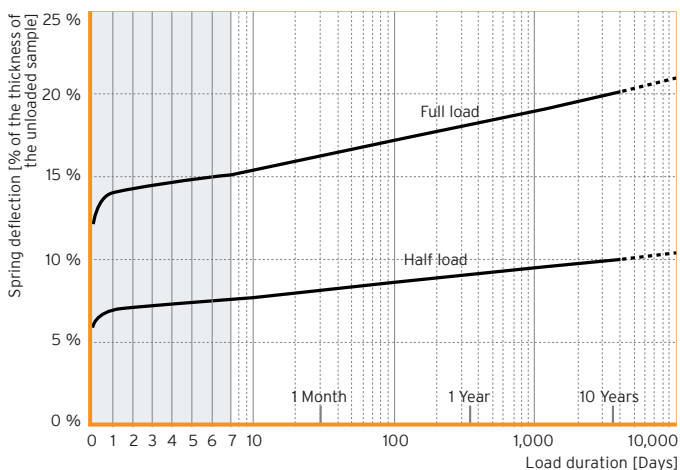

Diagram 6: Static long-term durability of Sylomer®

The bulk of the increase in deformation due to creeping occurs after a relatively short period of time. Subsequent to this short phase, the increase in deformation over a longer period of time is very small.

Getzner's 40 years of experience and numerous reference projects using Sylomer® bearings have repeatedly confirmed this pattern of behavior by the bearings under static long-term load.

Dynamic properties under long-term load

A change in the dynamic properties under long-term load conditions can be critical for elastic vibration-isolation bearings in particular. The recommendations for the static application range have been selected in such a manner that, under the maximum load for the static application range, the natural frequency of the system does not change during the load period. Diagram 7 illustrates these relationships:

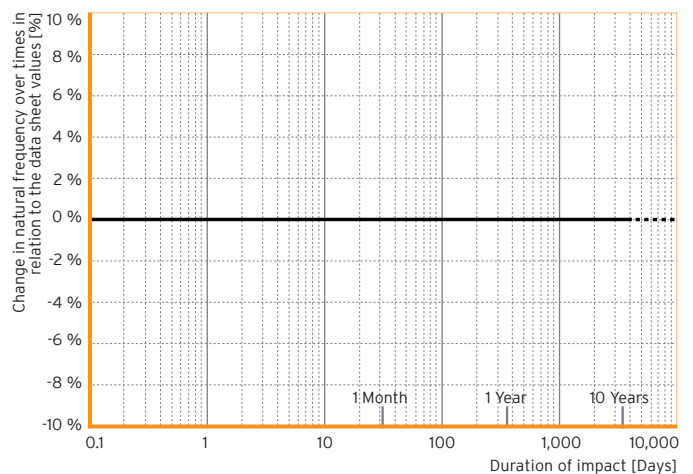

Diagram 7: Dynamic long-term durability of Sylomer®

Poisson's ratio

Poisson's ratio can only be stated with adequate precision for materials which are loaded in the linear range.

In general, however, Sylomer® is also subject to loads in the non-linear range, as a result of which disclosure of the Poisson's ratio as a discrete "single value" is not realistic.

The higher the density and hence the stiffness of the Sylomer®, the lower the degree of volume compressibility (ideally incompressible → Poisson's ratio 0.5).

Determination of the Poisson's ratio for Sylomer® is subject to corresponding fluctuations, depending on the material type (density) and the load (or testing method). The values for Sylomer® have been found to be between 0.3 and 0.5.

Influence of temperature

The working temperature range for Sylomer® materials should be between -30 °C and +70 °C. The glass transition temperature of Sylomer® is around -50 °C, and the melting temperature range spans from +150 °C to +180 °C. The maximum temperature to which Sylomer® can be briefly exposed to without permanent loss of the properties stated in the product sheet depends strongly on the specific application in question. Please contact the Support department at Getzner Werkstoffe for exact information.

The data listed in the product data sheets is valid for room temperature.

The respective dependencies for the individual material types with regard to temperature can be found in the Details Datasheet.

Frequency dependency

The e-modulus and the loss factor of Sylomer® are dependent on the deformation velocity, and thus on the frequency in cases of dynamic load. The dependency of Sylomer® on frequency can be found in the Details Datasheet.

Amplitude dependence

Sylomer® shows a low degree of dependency on amplitude, and as a result this can generally be disregarded in the calculations. This is a very important factor, in particular in the field of mounting systems for buildings and the related amplitudes.

Inflammability

Sylomer® materials are categorized in flammability class B2 as per DIN 4102 (normally combustible). No corrosive gases are generated in the event of combustion. The gases produced are similar in composition to those produced by the combustion of wood or wool.

Resistance to environmental conditions and chemicals

Sylomer® materials are resistant to substances such as water, concrete, oils and fats, diluted acids and bases. A detailed list of resistance to various materials is contained in the data sheet on chemical resistance.

Vibration isolation

Vibration isolation and isolation of structure-borne noise serve to reduce mechanically transmitted vibrations. This involves the reduction of forces and vibration amplitudes by the use of special visco-elastic construction elements which are aligned in the path of propagation of the vibrations. In the case of structure-borne noise isolation, in addition to the reduction in mechanical vibration, the secondary airborne noise generated by structure-borne noise is also mitigated.

For structure-borne noise isolation, the tuning frequencies are generally higher than those for vibration isolation. Vibration and structure-borne noise isolation is divided into

Emission isolation

with the goal reducing the forces transmitted by a machine or other source into the environment.

Immission isolation

to shield machines, equipment or buildings against vibrations from the environment.

Targeted use of visco-elastic construction elements and the possible deployment of additional masses generally allows for the realization of optimum solutions for vibration isolation for all applications.

One-dimension mass-spring systems

Many vibration problems can be approximated with a simple physical model, the so-called mass-spring system (see Diagram 8). If the mass is disturbed from the equilibrium position by a brief, external force, the mass oscillates at a natural frequency of f_0 (see Diagram 9)

1
$$f_0 = \frac{1}{2\pi} \cdot \sqrt{\frac{c}{m}} = \frac{1}{T}$$

- T = Period duration (s)
- f_0 = Natural frequency (Hz)
- c = Spring constant (N/m)
- m = Oscillating mass (kg)

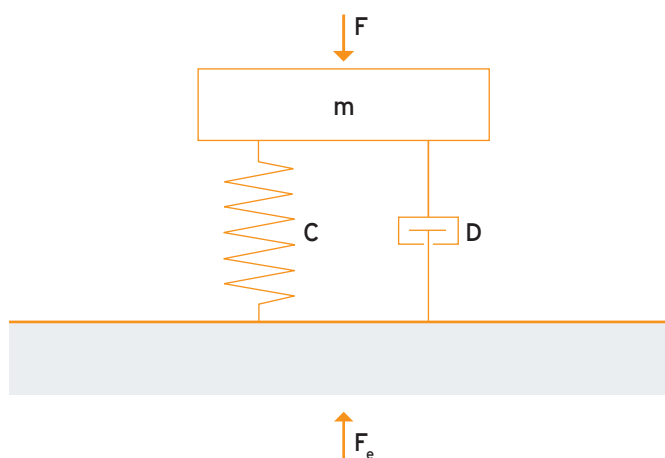

Diagram 8: One-dimensional mass-spring system

The amplitude of this vibration fades over time:

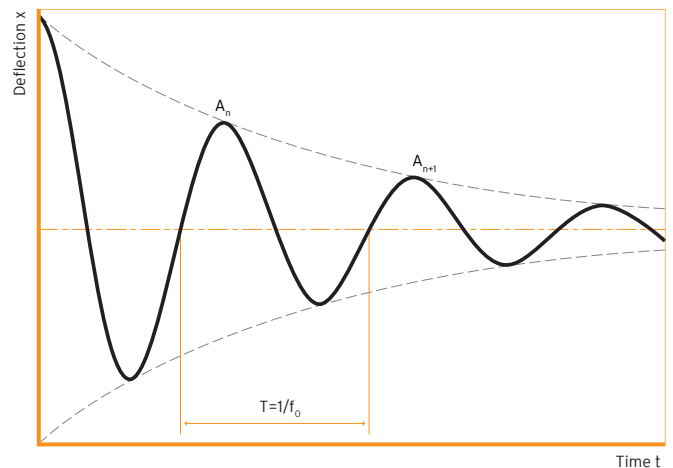

Diagram 9: Fading behavior of a free vibration displacement x

How quickly the amplitude fades depends on the dampening of the spring. For Sylomer® materials, dampening is described by the mechanical loss factor. Depending on the product type, the loss factor for Sylomer® ranges from $\eta = 0.09$ to $\eta = 0.25$.

The relationship between the mechanical loss factor η and the so-called critical dampening ratio D is the following:

2
$$\eta = 2D$$

The relationship between dampening and the ratio of two consecutive maximum amplitudes is described by the equation:

3
$$\frac{A_{n+1}}{A_n} = e^{-2D\pi} = e^{-\eta\pi}$$

Transmission function

The isolation effect of the elastic bearing is described with the transmission function $V(f)$. This refers to the force transmission function for the force excitation (emission isolation), and the amplitude transmission function for immersion isolation.

$$4 \quad V(f) = \sqrt{\frac{1 + \eta^2 \cdot \left(\frac{f}{f_0}\right)^2}{\left(1 - \left(\frac{f}{f_0}\right)^2\right)^2 + \eta^2 \cdot \left(\frac{f}{f_0}\right)^2}}$$

The transmission function describes the mathematical relationship between the system response (amplitude of the vibration) and the impact (amplitude of excitation) and is generally rendered as a function of the frequency ratio f/f_0 .

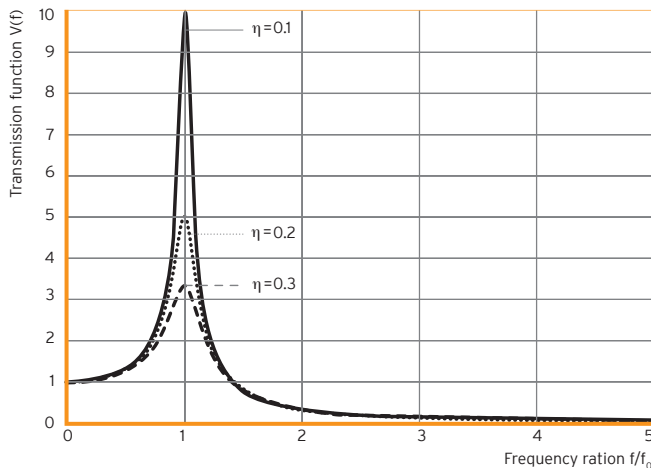

Diagram 10: Transmission function

An isolation effect only occurs in the frequency range $f/f_0 > \sqrt{2}$. So-called low frequency tuning occurs when the natural frequency f_0 of the system is around a factor of 1.41 lower than the lowest frequency f of the mechanical vibrations.

In the resonance range $f/f_0 < \sqrt{2}$ there is an amplification of the mechanical vibration in all cases, independent of the dampening.

Degree of transmission / isolation factor

The isolation effect is often presented logarithmically in a level form. In this case, the term used is degree of transmission $L(f)$ in dB.

$$5 \quad L(f) = 20 \cdot \log \left[\sqrt{\frac{1 + \eta^2 \cdot \left(\frac{f}{f_0}\right)^2}{\left(1 - \left(\frac{f}{f_0}\right)^2\right)^2 + \eta^2 \cdot \left(\frac{f}{f_0}\right)^2}} \right]$$

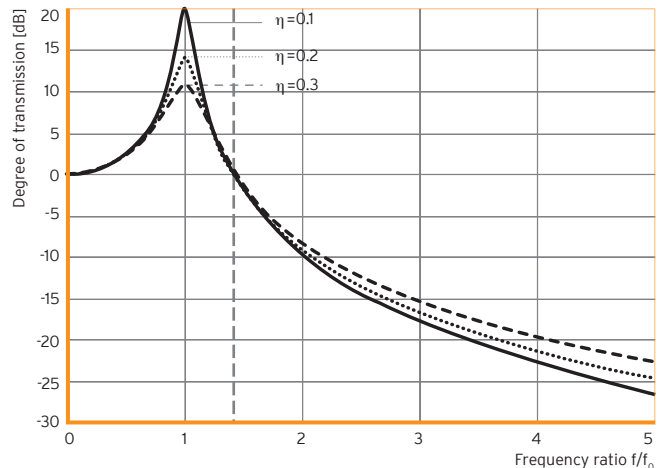

Diagram 11: Degree of transmission

Another useful variable is the isolation factor $I(f)$, which presents the reduction in the transmitted excitation factor in %:

$$6 \quad I(f) = 100 \cdot \left[1 - \sqrt{\frac{1 + \eta^2 \cdot \left(\frac{f}{f_0}\right)^2}{\left(1 - \left(\frac{f}{f_0}\right)^2\right)^2 + \eta^2 \cdot \left(\frac{f}{f_0}\right)^2}} \right]$$

Calculation of natural frequency and dampening effect with systems using Sylomer®

If only one type of Sylomer® is used, the natural frequency of the free vibration in line with the static design can be found in the product data sheets. In this regard, the natural frequency of the system depending on the surface pressure for various material thicknesses is presented in Point 3. Calculation of the natural frequency occurs in line with (1).

The dynamic spring constant of the bearing is calculated by:

$$7 \quad c = \frac{E \cdot A}{d}$$

E = Dynamic e-modulus (N/mm²)
 A = Bearing surface (mm²)
 d = Material thickness (mm)

As an alternative to (1), it is also possible to use the following formula:

$$8 \quad f_0 = 15.76 \sqrt{\frac{E}{d\sigma}}$$

σ = Surface pressure (N/mm²)

The dynamic e-modulus can be found for the surface pressure under Point 2 in the diagrams in the product data sheets. In all cases the material thickness of the Sylomer® bearing in the unloaded state is to be used for calculation of the dynamic spring constant as per (7). If various types of Sylomer® are combined, then it is necessary to use the overall stiffness of the bearing as a basis for the calculation of natural frequency as per (1). The overall stiffness is derived from the sum of the individual stiffnesses as per (7).

For bearings which are also subjected to shearing forces, it is necessary to use the dynamic shearing modulus in this regard, instead of the dynamic e-modulus.

Insertion loss and the isolation factor of the elastic bearing are dependent on the ratio of the excitation frequency to the natural frequency and the loss factor. They can be calculated using equations (5) and (6).

Moreover, both values are presented in dependence on the natural and excitation frequency in the product data sheets under Point 4.

Estimation of the natural frequency from the static subsidence as per the following formula (9) cannot be employed for Sylomer®.

$$9 \quad \cancel{f_0 = \frac{5}{\sqrt{x}}}$$

x = Static subsidence (cm)

Modeling

Calculation of the real oscillatory system occurs on the basis of a mechanical dummy model. For many real vibration problems, it is sufficient to use one-dimensional modeling as a mass-spring system. If one wishes to examine the oscillatory system more precisely, then one must allow for further movement possibilities which are relevant for the real system. Moreover, the oscillating mass can be represented by various discrete individual masses which are linked by springs or dampeners. The number of independent movement possibilities allowed for by the system are referred to as degrees of freedom. The number of degrees of freedom is identical to the number of possible natural frequencies.

For measuring vibration isolation, in general the lowest natural frequency is relevant. As this frequency is approximately the same for all models, a one-dimensional modeling as a mass-spring system is often sufficient.

All information and data is based on our current knowledge. The data can be applied for calculations and as guidelines, are subject to typical manufacturing tolerances, and are not guaranteed. We reserve the right to amend the data.

Getzner Werkstoffe GmbH

Herrenau 5
6706 Bürs
Austria
T +43-5552-201-0
F +43-5552-201-1899
info.buers@getzner.com

Getzner Werkstoffe GmbH

Am Borsigturm 11
13507 Berlin
Germany
T +49-30-405034-00
F +49-30-405034-35
info.berlin@getzner.com

Getzner Werkstoffe GmbH

Nördliche Münchner Str. 27a
82031 Grünwald
Germany
T +49-89-693500-0
F +49-89-693500-11
info.munich@getzner.com

Getzner Spring Solutions GmbH

Gottlob-Grotz-Str. 1
74321 Bietigheim-Bissingen
Germany
T +49-7142-91753-0
F +49-7142-91753-50
info.stuttgart@getzner.com

Getzner France S.A.S.

Bâtiment Quadrille
19 Rue Jacqueline Auriol
69008 Lyon
France
T +33-4 72 62 00 16
info.lyon@getzner.com

ClimatePartner 
neutral
printing



UZ-LZ 788

Getzner Werkstoffe GmbH

Middle East Regional Office
Abdul - Hameed Sharaf Str. 114
Rimawi Center - Shmeisani
P. O. Box 961 303
Amman 11196, Jordan
T +9626-560-7341
F +9626-569-7352
info.amman@getzner.com

Getzner India Pvt. Ltd.

1st Floor, Kaivalya
24 Tejas Society, Kothrud
Pune 411038, India
T +91-20-25385195
F +91-20-25385199

Nihon Getzner K.K.

6-8 Nihonbashi Odenma-cho
Chuo-ku, Tokyo
103-0011, Japan
T +81-3-6842-7072
F +81-3-6842-7062
info.tokyo@getzner.com

Beijing Getzner Trading Co.; Ltd.

Zhongyu Plaza, Office 1806
Gongti Beilu Jia No. 6
100027 Beijing, PR China
T +86-10-8523-6518
F +86-10-8523-6578
info.beijing@getzner.com

Getzner USA, Inc.

8720 Red Oak Boulevard, Suite 528
Charlotte, NC, 28217, USA
T +1-704-966-2132
info.charlotte@getzner.com

www.getzner.com

www.pyroteknc.com/contact-us

CONTACT DETAILS

for further information and contact
details, please visit our website at
www.pyroteknc.com

Pyrotek®